

NNH-Instrumentarium Sinus Instruments





Über uns

About Us

Geschichte

SPIGGLE & THEIS Medizintechnik GmbH wurde 1994 von den Geschäftsführern **David Spiggle** und **Detlef Theis** gegründet. Bis heute haben wir uns vom reinen Vertriebsunternehmen zu einem renommierten Hersteller von Medizinprodukten im Bereich der HNO-Chirurgie weiterentwickelt. Weltweit exportieren wir in über 75 Länder und in Deutschland zählen mehr als 700 Kliniken zu unseren Kunden.

Das Maß der Dinge

Im chirurgischen Instrumentenbau gilt das Siegel **“Made in Germany“** auch heute noch als Inbegriff von Qualität. Unsere chirurgischen Instrumente werden in allen Produktionsstufen unter strengsten Qualitätsanforderungen nahezu komplett in Deutschland produziert und sind somit noch größtenteils echt **“Made in Germany“**. Zur Verarbeitung wird ausschließlich Instrumentenstahl bester Güte verwendet, welcher den hohen Anforderungen moderner Chirurgie auch dauerhaft gerecht wird.

Sicherheit

Die Gesundheit der Patienten und somit die Sicherheit und Qualität unserer Produkte stehen im Mittelpunkt unseres Handelns. In diesem Sinne ist **SPIGGLE & THEIS Medizintechnik GmbH** bereits seit 1997 **ISO-zertifiziert** und sind unsere Produkte nach der strengen europäischen Richtlinie für Medizinprodukte CE-gekennzeichnet. Alle unsere Produkte unterliegen einer permanenten Qualitätskontrolle - von der Auswahl des Rohmaterials über die einzelnen Fertigungsschritte bis zum Versand.

Erfahrung

Unsere Mitarbeiter haben zum Teil mehr als 30 Jahre Berufserfahrung im Umgang mit chirurgischen Instrumenten. Durch dieses umfassende Know-How sowie den langjährigen und individuellen Kontakt mit den Anwendern, besitzen wir nicht nur theoretisches Wissen, sondern kennen auch deren Bedürfnisse und Ansprüche. Dies hilft uns bei der steten, praxisorientierten Weiterentwicklung unserer Produkte. Somit garantieren wir hohe Kompetenz und individuellen Service bei der Betreuung unserer Kunden.

History

SPIGGLE & THEIS Medizintechnik GmbH was founded in 1994 by the managing directors **David Spiggle** and **Detlef Theis**. The company has evolved from being purely a distributor to the established manufacturer of medical products in the area of ENT that it is today. We can count over 700 clinics amongst our German customers and export to over 75 countries world-wide.

The Seal Of Highest Quality

The stamp **“Made in Germany“** is still the epitome of quality standards in the production of surgical instruments in the world today. The majority of our surgical instruments is subjected to the strictest quality requirements at every step of their production, in the truest sense of the words, **“Made in Germany“**. Only the highest standard of instrument steel, capable of consistently meeting the demands of modern surgery, is used in the production.

Safety First

The health of our patients and therefore the safety and quality of our products plays the central role in our decisions. **SPIGGLE & THEIS Medizintechnik GmbH** has been **ISO certified**. Our products are CE-marked in accordance with the strict European guideline for medical products since 1997. All our products undergo continual quality checks, from the selection of raw materials, to the individual stages of production and finally their dispatch.

Experience

Our colleagues in instrument development can look back on over 30 years of professional practical experience with ENT surgical instruments. We offer more than theoretical knowledge – we understand our customer needs. We enjoy close, personal contact to many of the best surgeons world-wide. This enables us to continually develop innovative products. We guarantee the highest level of competence and individual service in meeting our customer requirements.



Inhaltsverzeichnis

Table of contents

01	Ambulantes Nasen-Nebenhöhlen-Instrumentarium / Diagnostic Sinus Instruments	5 - 8
02	Endoskopie und Videodokumentation / Endoscopy and Video Documentation	9 - 18
03	Septum-Instrumente / Septum-Instruments	19 - 26
04	FESS-Instrumente / FESS-Instruments	27 - 38
05	Dieler bipolare Koagulationszangen / Dieler bipolar coagulation forceps	39 - 42
06	Stirnhöhlen- und Keilbeinhöhlen-Instrumente / Frontal and Sphenoidal Instruments	43 - 49
07	Mikroskopische / Endoskopische Instrumente für die Pansinus-Chirurgie Microscopic / Endoscopic Instruments for Pansinus Surgery	50- 60
08	Allgemeines / Miscellaneous	61 - 65
09	Sterilisationssysteme / Sterilization Systems	66 - 67
10	Sets	68 - 70
	Index.....	71 - 74

Attention:

Not every instrument is available in all markets. Availability depends on local regulations. Please contact your SPIGGLE & THEIS representative or distributor, if you have any questions about the availability of our products in your region.

01 Ambulantes Nasen-Nebenhöhlen-Instrumentarium

Diagnostic Sinus Instruments

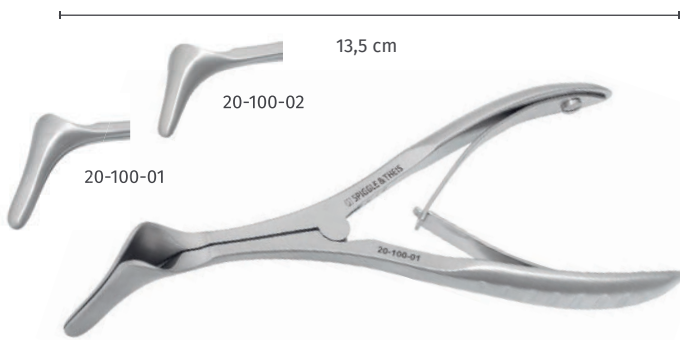

Hartmann Nasenspekulum, 13,5 cm
Hartmann nasal speculum, 13.5 cm

Art.-Nr./No.		Länge / Length (cm)
20-100-01	Für Erwachsene for adult	13,5
20-100-02	Für Jugendliche & Kinder for juveniles & children	13,5

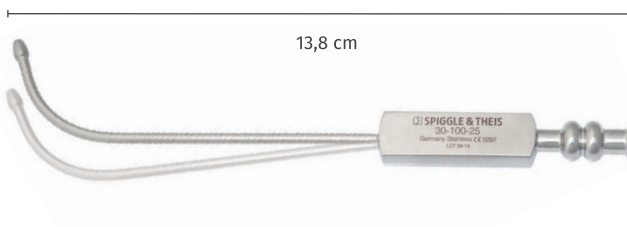

Eicken Spülröhrchen, lange Biegung, biegsam, 13,8 cm
Eicken antrum cannula, long curve, bendable, 13.8 cm

Art.-Nr./No.	AD / OD (mm)
30-100-25	2,5
30-100-30	3,0
30-100-40	4,0

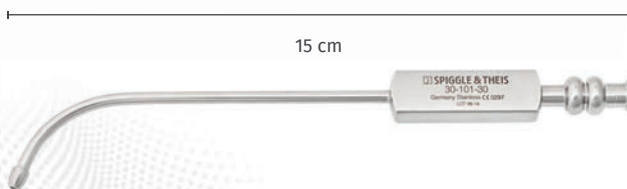

Eicken Spülröhrchen, lange Biegung, 15 cm
Eicken antrum cannula, long curve, 15 cm

Art.-Nr./No.	AD / OD (mm)
30-101-25	2,5
30-101-30	3,0
30-101-40	4,0

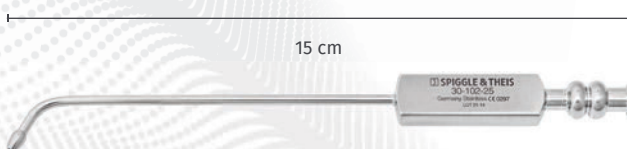

Eicken Spülröhrchen, kurze Biegung, 15 cm
Eicken antrum cannula, short curve, 15 cm

Art.-Nr./No.	AD / OD (mm)
30-102-25	2,5
30-102-30	3,0
30-102-40	4,0



01 Ambulantes Nasen-Nebenhöhlen-Instrumentarium Frazier Saugrohr

Diagnostic Sinus Instruments Frazier suction tube

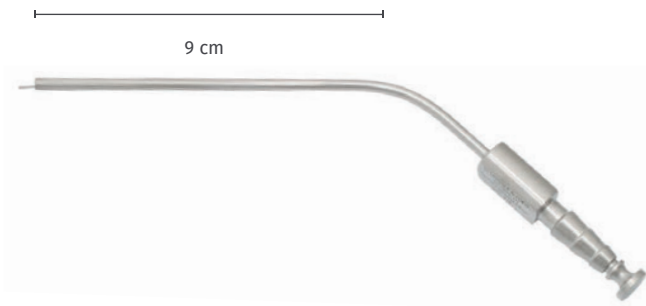

mit Griffplatte und Unterbrecher, 9 cm
with suction control, 9 cm

Art.-Nr. Art.-No.	AD / OD Ch/Fr	AD / OD mm
30-080-05	5	1,7
30-080-06	6	2,0
30-080-07	7	2,3
30-080-08	8	2,7
30-080-09	9	3,0
30-080-10	10	3,3
30-080-12	12	4,0
30-080-15	15	5,0

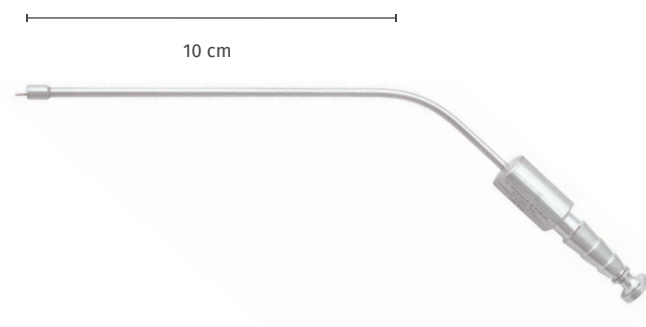

kniegebogen, Knopfende, 10 cm / angled, ball ended, 10 cm

Art.-Nr. Art.-No.	AD / OD Ch/Fr	AD / OD mm
30-082-08	8	2,7
30-082-10	10	3,3
30-082-12	12	4,0
30-082-15	15	5,0

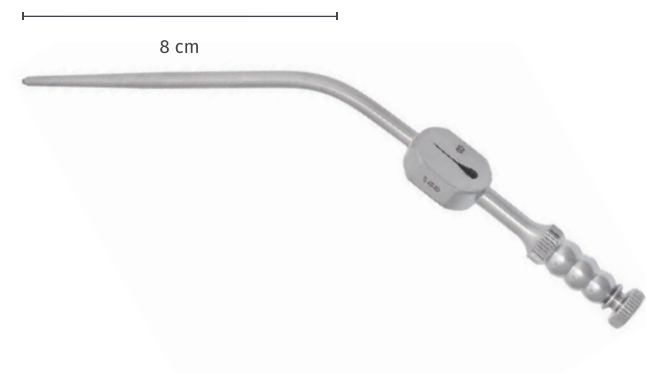

konisch, mit tränenförmiger Sogsteuerung, 8 cm
conical, with tear formed suction control, 8 cm

Art.-Nr. Art.-No.	AD / OD Ch/Fr	AD / OD mm
30-105-06	6	2,0
30-105-08	8	2,7
30-105-10	10	3,3

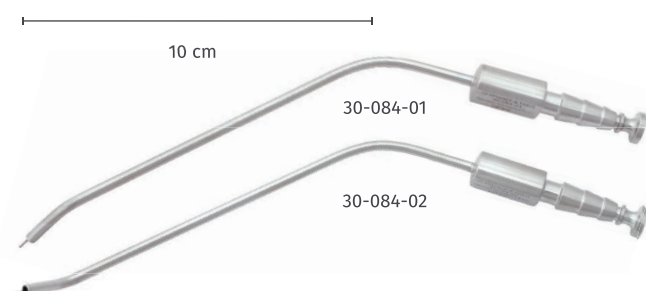

mit Unterbrecher, 10 Ch (3,3 mm), 10 cm
with suction control, 10 Ch (3.3 mm), 10 cm

Art.-Nr./No.	Beschreibung / Description
30-084-01	rechts gebogen / curved right
30-084-02	links gebogen / curved left

01 Ambulantes Nasen-Nebenhöhlen-Instrumentarium

Diagnostic Sinus Instruments



Stirnhöhlen-Saugrohr, biegsam, 16,5 cm
Frontal sinus suction tube, bendable, 16.5 cm

Art.-Nr./No.	AD / OD (mm)
30-106-25	2,5
30-106-30	3,0
30-106-40	4,0



Stirnhöhlen Saugraspatorium, gebogen, biegsam, mit Sogsteuerung, 10 cm
Frontal sinus suction raspatory, curved, bendable, with suction control, 10 cm

30-108-00

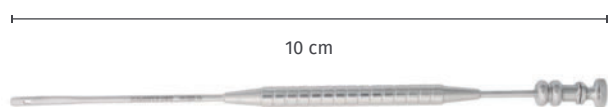

Gourney Sauglevatorium, 3 mm, 19 cm
Gourney suction elevator, 3 mm, 19 cm

20-320-19



Lichtwitz Punktionskanüle, 10 cm / Lichtwitz trocar needle, 10 cm

Art.-Nr./No.	AD / OD (mm)
30-111-16	1,5
30-111-18	1,8



Kieferhöhlen-Spülschlauch, 30 cm / Sinus irrigation tube, 30 cm

Art.-Nr./No.	Beschreibung / Description
30-112-00	Silikon, mit Ansätzen silicone, with connectors



01 Ambulantes Nasen-Nebenhöhlen-Instrumentarium

Diagnostic Sinus Instruments

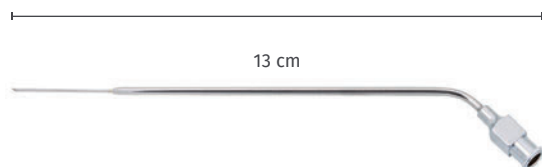

Injektionskanüle, kniegebogen, AD 0,8 mm, 13 cm

Injection needle, angled, OD 0.8 mm, 13 cm

30-122-08

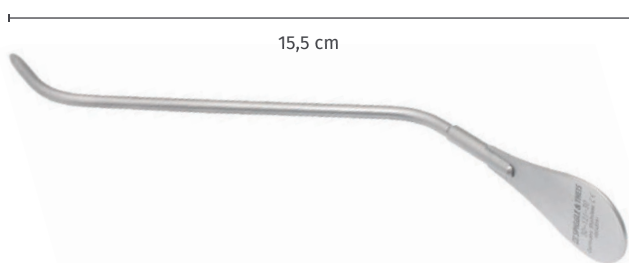

Ritter Stirnhöhlenbougie, 15,5 cm

Ritter frontal sinus bougie, 15.5 cm

Art.-Nr./No.	AD / OD (mm)
30-121-25	2,5
30-121-30	3,0
30-121-40	4,0
30-121-50	5,0

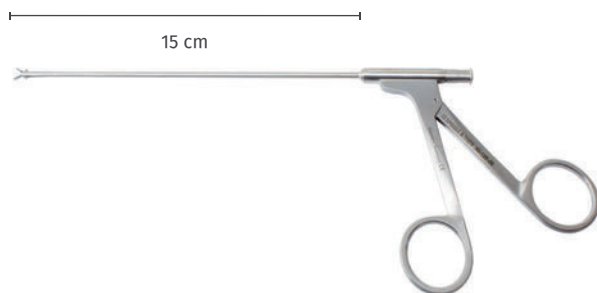

Biopsiezange, gerade, doppelbeweglich, Löffel 2x4 mm,

AD 2,5 mm, Arbeitslänge 15 cm, mit Spülkanal

Biopsy forceps, straight, double-action, cup 2x4 mm,

OD 2.5 mm, working length 15 cm, with irrigation channel

30-125-00

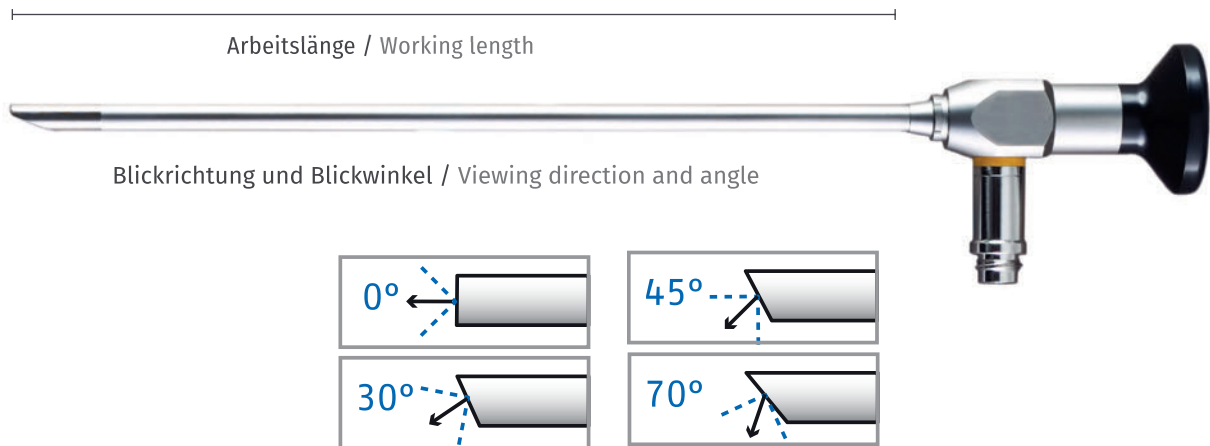

Vorteile unserer Endoskope:

- Kompatibel mit allen Lichtquellen auf dem Markt (universalkompatibel)
- Extrem robuste Rohrkonstruktion mit verstärktem 2-Rohr-Edelstahl-System
- Hochwertig vergütetes, hochauflösendes Linsen-System
- Optische Saphirglas-Frontlinse, kratzfest und hitzebeständig fixiert mit Epoxidharz
- Hitzebeständiges Polymer-Okular (PEEK)
- Hohe Dichtigkeit durch gelaserte Schnittstellen
- Mehr Bildinformation durch großen Öffnungswinkel
- Hohe Bildschärfe im gesamten Bildbereich
- Gleichmäßige Helligkeit bis zum Rand durch Lichtkonus
- Autoklavierbar
- 24 Monate Garantie

Advantages of our endoscopes:

- Compatible to all light sources available (universal camera compatible)
- Extremely robust stainless steel tube construction with reinforced outer tube
- High precision quality lens system
- Optical sapphire glass front lens, scratch resistant and fixed with heat-resistant epoxide
- Heat-resistant polymer ocular (PEEK)
- Tight sealing due to laser welded joints
- More image information due to wide viewing angle
- High focus quality in entire viewing area
- Constant brightness up to the edge of viewing area
- Autoclavable
- 24 months guarantee

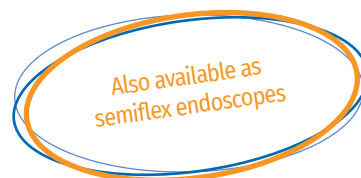

All unsere Endoskope sind aus Phynoxstahl
für verbesserten Schutz gegen Verbiegen und Bruch

All our endoscopes are made of phynox steel
for improved protection against bending or break

02 Endoskopie und Videodokumentation Sinuskop, HD

Endoscopy and Video Documentation Sinuscope, HD

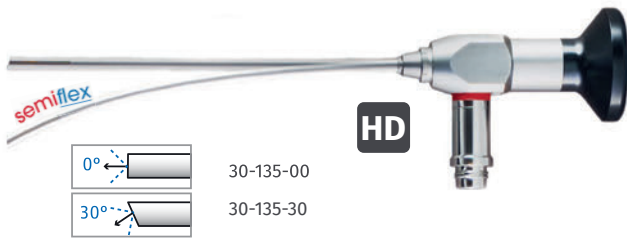

semiflex, autoklavierbar, AD 2,7 mm, 11 cm
semiflex, autoclavable, OD 2.7 mm, 11 cm

Art.-Nr./No.	Winkel / Angle
30-135-00	0°
30-135-30	30°

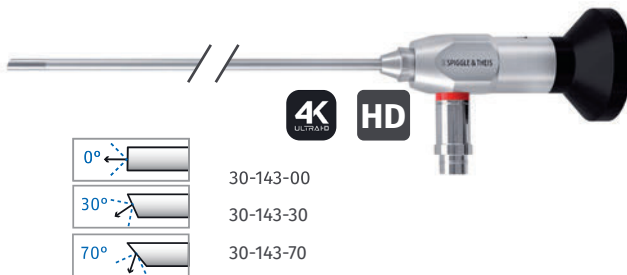

4K, starr, autoklavierbar, AD 4,0 mm, 17,5 cm
4K, rigid, autoclavable, OD 4.0 mm, 17.5 cm

Art.-Nr./No.	Winkel / Angle
30-143-00	0°
30-143-30	30°
30-143-70	70°

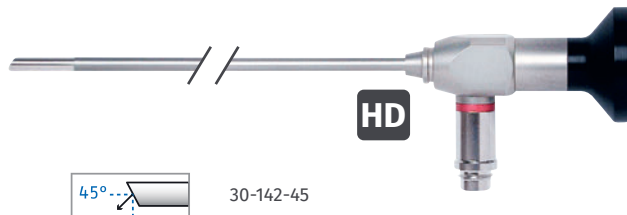

starr, autoklavierbar, AD 4,0 mm, 17,5 cm
rigid, autoclavable, OD 4.0 mm, 17.5 cm

Art.-Nr./No.	Winkel / Angle
30-142-45	45°
30-142-90	90°

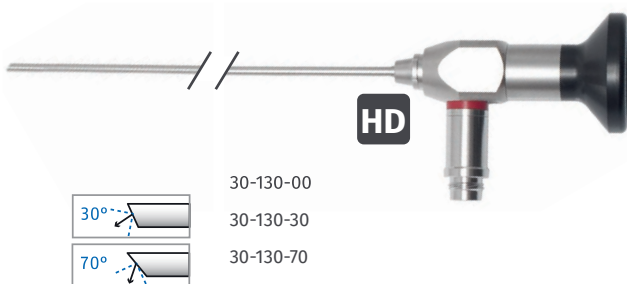

starr, autoklavierbar, AD 2,7 mm, 18,75 cm
rigid, autoclavable, OD 2.7 mm, 18.75 cm

Art.-Nr./No.	Winkel / Angle
30-130-00	0°
30-130-30	30°
30-130-70	70°

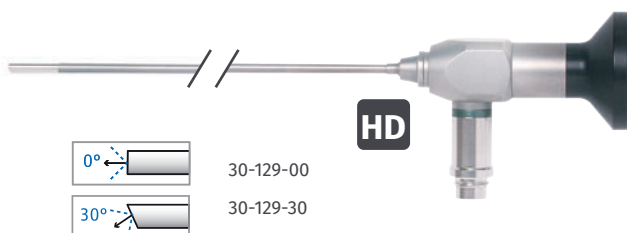

starr, autoklavierbar, AD 2,7 mm, 11 cm
rigid, autoclavable, OD 2.7 mm, 11 cm

Art.-Nr./No.	Winkel / Angle
30-134-00	0°
30-134-30	30°

02 Endoskopie und Videodokumentation

Endoscopy and Video Documentation

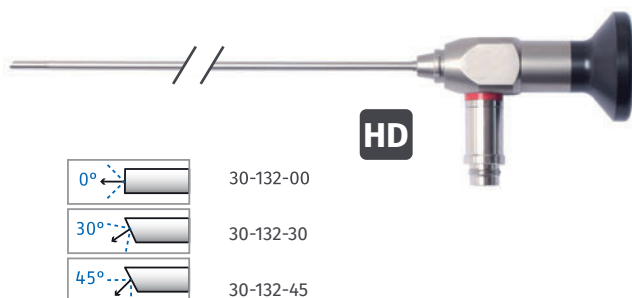

starr, autoklavierbar, AD 2,7 mm, 14,1 cm
rigid, autoclavable, OD 2.7 mm, 14.1 cm

Art.-Nr./No.	Winkel / Angle
30-132-00	0°
30-132-30	30°
30-132-45	45°

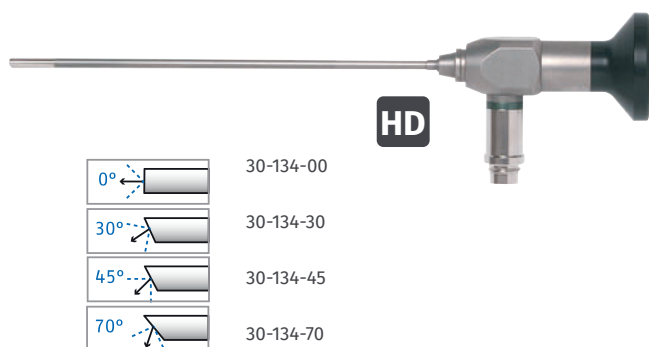

starr, autoklavierbar, AD 2,7 mm, 11 cm
rigid, autoclavable, OD 2.7 mm, 11 cm

Art.-Nr./No.	Winkel / Angle
30-134-00	0°
30-134-30	30°
30-134-45	45°
30-134-70	70°



Sterilisations-Container für Endoskope

Ø 2,5 - 5,0 mm, Länge bis zu 19,5 cm

Sterilizing & protecting tray for endoscopes

Ø 2.5 - 5.0 mm, up to 19.5 cm length

Art.-Nr./No.	
80-621-05	für 2 Endoskope / for 2 endoscopes
80-622-56	für 6 Endoskope, 1 Lichtkabel for 6 endoscopes, 1 light-cable
80-623-22	für 2 Endoskope, 1 Lichtkabel, 1 Kamerakopf for 2 endoscopes, 1 light-cable, 1 camera head



02 Endoskopie und Videodokumentation

Endoscopy and Video Documentation



Endoskop-Handgriff, rund, Edelstahl, Griffmulde, 11 cm

Endoscope handle, round, stainless steel, moulded grip, 11 cm

Art.-Nr./No.	Beschreibung / Description
30-151-27	für 2,7 mm Endoskope for 2.7 mm endoscopes
30-151-40	für 4,0 mm Endoskope for 4.0 mm endoscopes

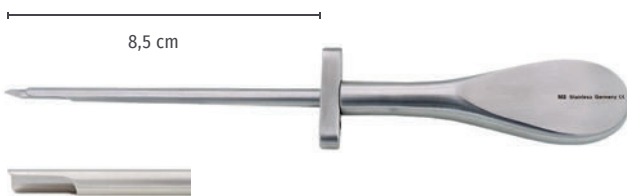

Antrum-Trokar, schnabelförmig, 5,0 x 4,0 mm, AL 8,5 cm, für 4 mm Endoskope

Antrum trocar, beaked, 5.0 x 4.0 mm, WL 8.5 cm, for 4 mm endoscopes

30-155-50

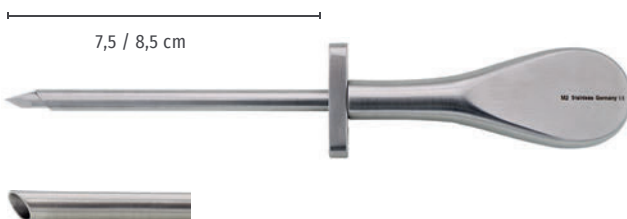

Antrum-Trokar, schräges Ende, für Endoskope

Antrum trocar, oblique tip, for endoscopes

Art.-Nr./No.	Beschreibung / Description
30-156-33	3,3 x 2,8 mm, AL 7,5 cm, für 2,7 mm Endoskope 3,3 x 2,8 mm, WL 7.5 cm, for 2.7 mm endoscopes
30-156-40	4,0 x 3,0 mm, AL 8,5 cm, für 3,0 mm Endoskope 4,0 x 3,0 mm, WL 8.5 cm, for 3.0 mm endoscopes
30-156-50	5,0 x 4,0 mm, AL 8,5 cm, für 4,0 mm Endoskope 5,0 x 4,0 mm, WL 8.5 cm, for 4.0 mm endoscopes



Ultra-Stop Antibeschlagmittel / Ultra-Stop Anti-Fog solution

Art.-Nr./No.	Beschreibung / Description
30-160-01	25 ml Pipettenflasche, unsteril 25 ml pipette bottle, non-sterile
30-160-02	30 ml Durchstichflasche, steril 30 ml pierce bottle, sterile
30-160-03	15 ml Sprayflasche, unsteril 15 ml spray bottle, non-sterile

02 Endoskopie und Videodokumentation

Endoscopy and Video Documentation



Dr. Fog original Antibeschlagmittel mit Schwamm, steril
Dr. Fog original anti-fog with sponge, sterile

30-160-04



Antifog Antibeschlag-Satz, steril, 48 Stück/Box
Antifog-Solution Kit, sterile, 48 pieces/box

30-160-05



Saug- und Spülhandgriff für Endoskope
Suction- and irrigation handle for endoscopes

30-161-00



16 / 17,5 cm



Saug- und Spülschaft für Endoskope
Suction and irrigation sheath for endoscopes

Art.-Nr. Art.-No.	Größe Size (mm)	Länge Length (cm)	Winkel Angle
30-164-00	4,0	16,0	0°
30-164-30	4,0	16,0	30°
30-164-45	4,0	16,0	45°
30-164-70	4,0	16,0	70°
30-167-00	2,7	17,5	0°
30-167-30	2,7	17,5	30°

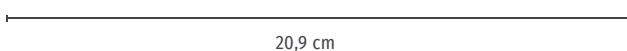

20,9 cm



Endoskop-Schutzhülse, 20,9 cm, verlängerbar,
autoklavierbar, für ein Endoskop 40-110-xx oder 40-112-xx.
(Für 40-112-xx werden 2 Schutzhülsen benötigt)

Endoscope protective sleeve, 20.9 cm, extendable, autoclavable,
for endoscope 40-110-xx or 40-112-xx.
(Two protective sleeves are needed for 40-112-xx)

(Two protective sleeves are needed for 40-112-xx)

30-182-21





LED-Leuchtgriffe / LED light handles

Art-Nr./No.

70-211-00 LED-Hochleistungs-Leuchtgriff, 230 V, bestehend aus: (70-211-10, 70-211-20, 70-211-30, 70-211-40)
LED high performance light-handle, 230 V, consisting of: (70-211-10, 70-211-20, 70-211-30, 70-211-40)

70-211-01 LED-Hochleistungs-Leuchtgriff, 120 V, bestehend aus: (70-211-10, 70-211-20, 70-211-30, 70-211-50)
LED high performance light-handle, 120 V, consisting of: (70-211-10, 70-211-20, 70-211-30, 70-211-50)

70-211-10 LED-Handgriff, schwarz, mit Helligkeitsdimmer, Ausschaltautomatik, 3 W, 5500° K, 17500 Lux, zur Verwendung mit Li-Io-Akku 3,5 V und Endoskop-Adapter, 50 Std. Brenndauer
LED light handle, black, with brightness dimmer, automatic switch-off, 3 W, 5500° K, 17500 lux, to use with Li-ion chargeable battery 3.5 V and endoscope adapter, 50 hours run-time

70-211-20 Li-Ionen-Akku, 3,5 V, für LED-Handgriff
Li-ion rechargeable battery, 3.5 V, for LED light-handle

70-211-30 Endoskopie-Adapter für LED-Handgriff, passend für Standardgewinde an Endoskopen (AcMI-Gewinde)
Endoscope adapter for LED light-handle, fits standard endoscope threads (AcMi-thread)

70-211-40 Ladegerät für bis zu 2 LED-Handgriffe, 3,5 V, 230 V, Standgerät, Wandhalterung
Charging base for up to 2 LED light-handles, 3.5 V, 230 V, table model, with wall holder

70-211-50 Ladegerät für bis zu 2 LED-Handgriffe, 3,5 V, 120 V, Standgerät, Wandhalterung
Charging base for up to 2 LED light-handles, 3.5 V, 120 V, table model, with wall holder

02 Endoskopie und Videodokumentation, Flexibles Nasopharyngoskop

Endoscopy and Video Documentation, Flexible Nasopharyngoscope

Arbeitslänge	32 cm
Working length	32 cm
Abwinkelung (auf / ab)	130°
Angle (up / down)	130°
Biegeradius	8 mm
Bending radius	8 mm
Blickfeld	80°
Field of vision	80°
Tiefenschärfe	1-50 mm
Depth of focus	1-50 mm
Gewicht	230 g
Weight	230 g



Art-Nr./No.

30-170-28	2,8 mm
30-170-36	3,4 mm
30-171-40	4,0 mm mit Arbeitskanal 4.0 mm with working channel

Die SPIGGLE & THEIS Nasopharyngoskope der neuen Generation sind intuitiv bedienbar und ergonomisch geformt. Sie wurden für die notwendige Feinfühligkeit im täglichen Routineeinsatz und für eine ermüdungsfreie Handhabung entwickelt.

Hochwertige Bildleiter und ein leistungsfähiges optisches System liefern große und helle Bilder bester Auflösung - die Voraussetzung für eine sichere Diagnose und Therapie. Dank solider Verarbeitung und konsequenter Verwendung moderner Hochleistungswerkstoffe sind SPIGGLE & THEIS Nasopharyngoskope robuster und langlebiger - trotz steigender Belastung durch moderne Aufbereitungsverfahren.

The new generation of SPIGGLE & THEIS nasopharyngoscopes impresses with intuitive operability and optimal ergonomics, designed for tactile sensation and non-tiring handling as required in daily routine operations.

High-end fibre-optic bundles and a high-capacity system produce large and bright images of the best quality - necessary for safe diagnosis and treatment. Due to the consistent use and reliable processing of high-class materials, the SPIGGLE & THEIS nasopharyngoscopes are robust and durable, in spite of the increasing stress of modern cleaning and sterilizing facilities.

Vorteile unserer Endoskope:

- Funktionelles Design für eine einfache und komfortable Handhabung
- Feinfühlig, aber robuste Steuerung
- Optimale Flexibilität und Torsionssteifigkeit des Einführungsschafts
- Leistungsfähiges optisches System: größere, hellere und schärfere Bilder

Geeignete Wiederaufbereitungsverfahren:

- Einlegbar in Reinigungs- und Desinfektionslösung
- STERIS
- NTDF-Sterilisation = Niedertemperatur-Dampf-Formaldehyd-Sterilisation
- Maschinelle Aufbereitung (RDG-E)

Advantages of our endoscopes:

- Functional design for easy and comfortable handling
- Sensitive yet robust control
- Optimal flexibility and torsional rigidity of the insertion channel
- High-performance optical system for larger, brighter and sharper images

Suitable reprocessing procedures:

- Fully immersible in cleaning and disinfectant solutions
- STERIS
- LTSF-sterilization = Low-Temperature Steam and Formaldehyde sterilization
- Machine reprocessing (RDG-E)





Dichtigkeitstester für flexible Endoskope
Leak tester for flexible endoscopes

30-169-08



Flexible Biopsiezange, Ø 1 mm, ovaler Löffel,
für flexibles Endoskop 30-171-40

Flexible biopsy forceps, Ø 1 mm, oval cups,
for flexible endoscope 30-171-40

Art.-Nr./No.	Länge / Length (cm)
30-172-40	120
30-172-41	40

Flexible Alligator-Fasszange, Ø 1 mm,
gezahntes Maul, für flexibles Endoskop 30-171-40

Flexible alligator forceps, Ø 1 mm,
serrated jaws, for flexible endoscope 30-171-40

Art.-Nr./No.	Länge / Length (cm)
30-173-40	120
30-173-41	40



Reinigungsbürste mit Grifföse, AL 40 cm, Bürste Ø 2,0 mm, Besatz-
länge 10 mm, für Arbeitskanal bis 1,5 mm, 10 Stück / Box, Einweg
Cleaning brush with loop, WL 40 cm, brush Ø 2.0 mm, length of
edging 10 mm, for working channels up to 1.5 mm, 10 pieces/ box,
single use

30-175-40

02 Endoskopie und Videodokumentation

Endoscopy and Video Documentation



MATRIX LED duo 2,
LED Hochleistungslichtquelle, 2 Lichtauslässe, 100-240 V
MATRIX LED duo 2,
LED high-performance light source, 2 light outputs, 100-240 V
70-203-00



Hochleistungs-Fiberglas-Lichtleitkabel,
SPIGGLE & THEIS-Anschlüsse, autoklavierbar
High definition fibre light cable,
SPIGGLE & THEIS connection, autoclavable

Art.-Nr./No.	AD / OD (mm)	Länge / Length (cm)
70-258-35	3,5	180
70-258-48	4,8	180
70-259-35	3,5	230
70-259-48	4,8	230
70-260-35	3,5	300
70-260-48	4,8	300



Hochleistungs-Fiberglas-Lichtleitkabel,
Ø 3,5 mm, 1800 mm, 90° abgewinkelt, autoklavierbar
High definition fibre light cable,
Ø 3.5 mm, 1800 mm, 90° angled, autoclavable

Art.-Nr./No.	Beschreibung / Description
70-265-01	Wolf/Wolf-Adapter / connector Geräteseitig abgewinkelt / lightsource side angled
70-265-02	Storz/Storz-Adapter / connector Geräteseitig abgewinkelt / lightsource side angled
70-266-02	Storz/Storz-Adapter / connector Endoskopseitig abgewinkelt / endoscope side angled



Hochleistungs-Fiberglas-Lichtleitkabel,
Ø 3,5 mm, 3000 mm, Endoskopseitig 90° abgewinkelt,
Storz/Storz Anschlüsse, autoklavierbar
High definition fibre light cable, Ø 3.5 mm, 3000 mm,
90° endoscope side angled, Storz/Storz connector,
autoclavable
70-267-03

Weitere Lichtleitkabel und Adapter auf Anfrage
More light cables and connectors on request



02 Endoskopie und Videodokumentation

Endoscopy and Video Documentation



**Desinfektionssystem für starre und flexible Endoskope,
720 x 120 x 60-120 mm**

**Disinfection system for rigid and flexible endoscopes,
720 x 120 x 60-120 mm**

70-470-00



**Desinfektions-Wandhalterung für flexible Endoskope,
4 Glasköcher, Aufhängung höhenverstellbar, Timer,
233 x 750 x 60 mm (Lieferung ohne Endoskop)**

**Disinfection wall holder, for flexible endoscopes,
4 glass tubes, hanging height adjustable, timer,
233 x 750 x 60 mm (Delivery without endoscope)**

70-472-00

03 Septum-Instrumente

Septum Instruments



Killian-Struycken Septumspeculum, 13,5 cm
Killian-Struycken septum speculum, 13.5 cm

Art.-Nr./No.	Größe / Size (cm)
20-150-40	40
20-150-55	55
20-150-65	65
20-150-75	75
20-150-90	90



Joseph Schere, spitz-spitz, gebogen 14,5 cm
Joseph scissors, pointed, curved, 14.5 cm

20-601-14

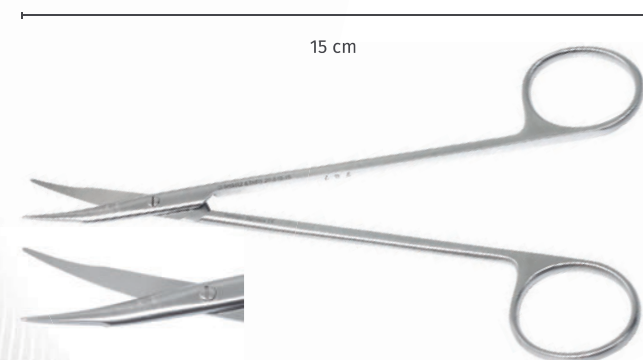

Reynolds Schere, stumpf-stumpf, gebogen, verjüngte Spitzen, 15 cm
Reynolds scissors, blunt-blunt, curved, tapered tips, 15 cm

20-610-15



Walter Schere, abgewinkelt, 10 cm
Walter scissors, angled, 10 cm

20-630-10



03 Septum-Instrumente

Septum Instruments

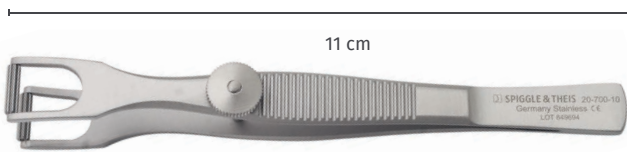

Cottle Columella-Klemme, 11 cm / Cottle columella forceps, 11 cm

20-700-10



Adson-Brown Pinzette, 7:8 Zähne, 12,5 cm

Adson-Brown forceps, 7:8 teeth, 12.5 cm

20-710-12

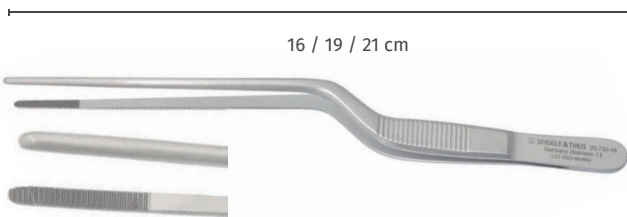

Jansen Nasenpinzette, bajonett, anatomisch

Jansen nasal forceps, bayonet, anatomical

Art.-Nr./No.	Länge / length (cm)	Beschreibung / Description
20-730-16	16	
20-730-19	19	
20-730-21	21	
20-731-16	16	1:2 Zähne/1:2 teeth

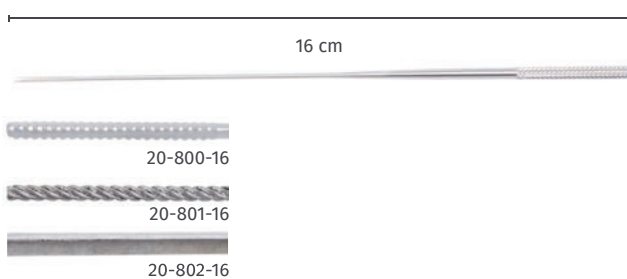

Watteträger, Ø 1,2 mm, 16 cm, 5 Stück

Cotton carrier, Ø 1.2 mm, 16 cm, 5 pieces

Art.-Nr./No.	Beschreibung / Description
20-800-16	dreikant, gerieft / triangle, serrated
20-801-16	rund, gerieft / round, serrated
20-802-16	dreikant, glatt / triangular, smooth



Cottle Septum-Messer, 14 cm / Cottle septum knife, 14 cm

20-500-13

03 Septum-Instrumente

Septum Instruments

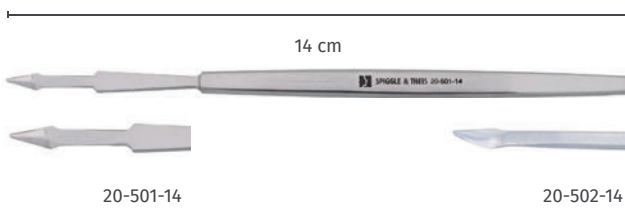

Masing Ritzmesser, 14 cm / Masing pointed knife, 14 cm

Art.-Nr./No.	Beschreibung / Description
20-501-14	mit Kerbe / grooved
20-502-14	glatt / smooth



Masing Elevatorium/Raspatorium, 21 cm

Masing elevator/raspatory, 21 cm

20-300-21

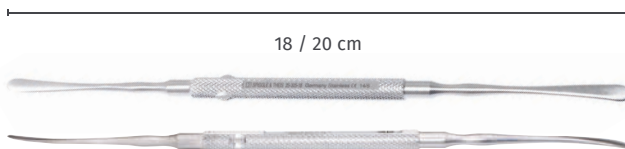

Freer Doppelevatorium, scharf-stumpf

Freer elevator, double ended, sharp-blunt

Art.-Nr./No.	Länge / length (cm)
20-305-18	18
20-306-20	20



Weber Doppelevatorium, scharf/stumpf, 18,5 cm

Weber elevator, double ended, sharp/blunt, 18.5 cm

20-307-18

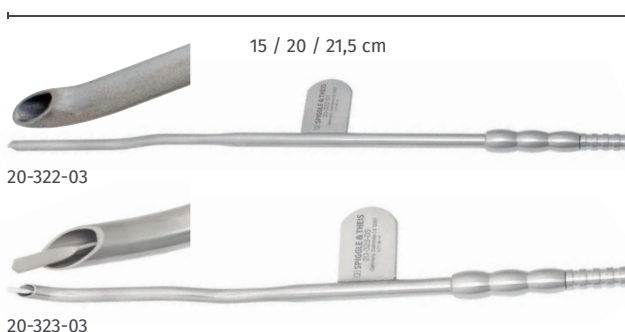

Guillen Saugraspatorium, 4,5 mm

Guillen suction raspatory, 4.5 mm

Art.-Nr./No.	Beschreibung / Description
20-322-01	20 cm, gerade / straight
20-322-02	20 cm, links gebogen / curved left
20-322-03	21,5 cm, rechts gebogen / curved right
20-323-01	15 cm, gerade / straight
20-323-02	15 cm, links gebogen / curved left
20-323-03	15 cm, rechts gebogen / curved right



03 Septum-Instrumente

Septum Instruments

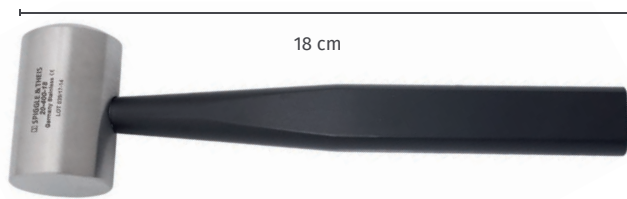

Cottle Hammer, 18 cm

Cottle mallet, 18 cm

20-400-18

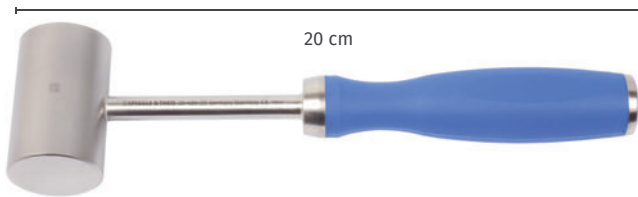

Hammer, mit Silikongriff, 20 cm

Mallet, with silicone handle, 20 cm

20-404-20



Cottle Meißel, flach, 18,5 cm / Cottle chisel, flat, 18.5 cm

Art.-Nr./No.	Größe / Size (mm)
20-405-04	4,0
20-405-07	7,0
20-405-09	9,0
20-405-10	10,0
20-405-12	12,0

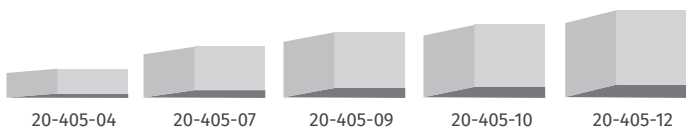

Crile-Wood Nadelhalter, Hartmetall, 15 cm

Crile-Wood needleholder, tungsten carbide, 15 cm

20-740-15

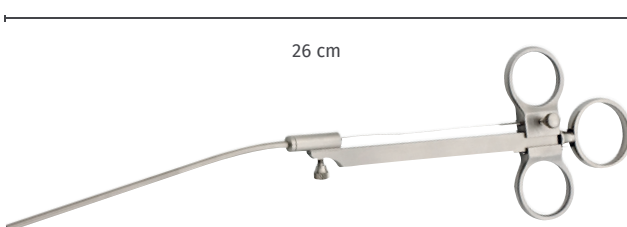

Krause Nasen-Polypen-Schnürer, scharf, 26 cm

Krause nasal polyp snare, sharp, 26 cm

20-190-25

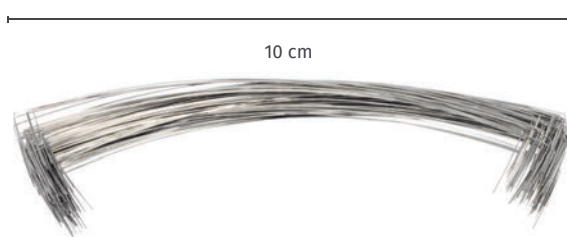

Nasenpolypenschlingen, 0,35 mm, 10 cm, 100 Stück

Nasal polyp snare wires, 0.35 mm, 10 cm, 100 pieces

20-195-35

03 Septum-Instrumente

Septum Instruments



Nasensonde, s-förmig gebogen, biegebar, 17,5 cm
Nasal probe, s-shaped, bendable, 17.5 cm

20-313-00



Cottle Nasenflügelhaken, 16,5 cm / Cottle alar retractor, 16.5 cm

20-560-15



Bipolare Pinzette, NON-STICK, bajonett, Spitze 0,5 mm, 16 cm
Bipolar forceps, NON-STICK, bayonet, tip 0.5 mm, 16 cm

80-110-16



Geräteseitig, 22 mm, passend für / unit-side, 22 mm, compatible to Erbe / EMC / Dolly

Art.-Nr./No.	Länge / Length (m)
80-316-50	5



Geräteseitig, passend für / unit-side, compatible to Sutter/Martin/Berchtold/Aesculap/Integra/SPIGGLE & THEIS

Art.-Nr./No.	Länge / Length (m)
80-317-30	3
80-317-50	5



Geräteseitig, 29 mm, passend für / unit-side, 29 mm, compatible to Valleylab/Lamidey/EMC/Bowa/Olympus

Art.-Nr./No.	Länge / Length (m)
80-319-30	3
80-319-50	5

* Abbildungen der Kabel sind ähnlich / images similar to product



03 Septum-Instrumente Blakesley Nasenzange Premium Modell

Septum Instruments Blakesley premium model nasal forceps

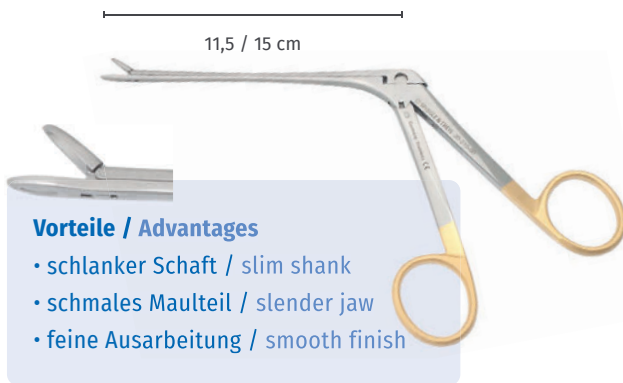

gerade / straight

Art.-Nr. Art.-No.	Größe Size (mm)		Länge Length (cm)
20-215-00	3,0		11,5
20-215-01	3,5		11,5
20-215-02	4,0		11,5
20-215-03	5,0		11,5
20-215-04	6,0		11,5
20-215-10	3,0		15,0
20-215-12	4,0		15,0
20-215-14	6,0		15,0

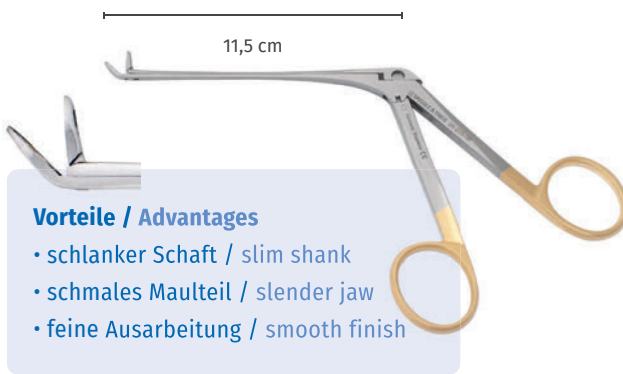

45° aufgebogen, 11,5 cm / curved upwards 45°, 11.5 cm

Art.-Nr./No.	Größe / Size (mm)	
20-225-00	3,0	
20-225-01	3,5	
20-225-02	4,0	
20-225-03	5,0	
20-225-04	6,0	

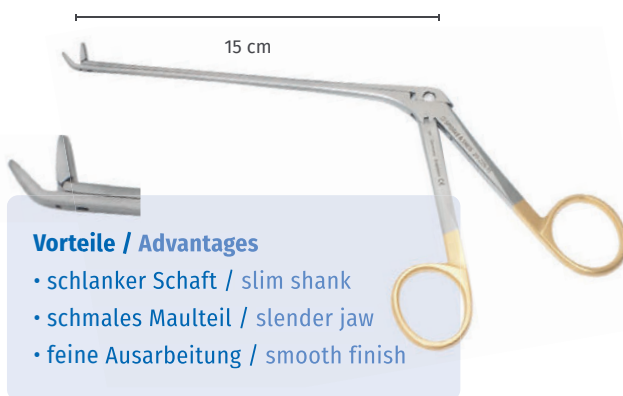

90° aufgebogen, 11,5 cm / curved upwards 90°, 11.5 cm

Art.-Nr./No.	Größe / Size (mm)	
20-235-01	3,5	
20-235-02	4,0	
20-235-03	5,0	

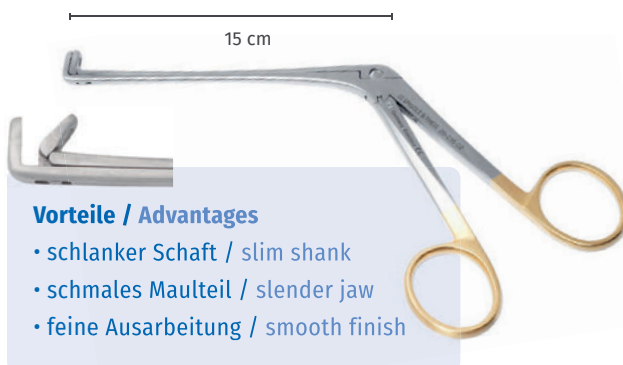

45° aufgebogen, 15 cm / curved upwards 45°, 15 cm

Art.-Nr./No.	Größe / Size (mm)	
20-225-11	3,5	
20-225-12	4,5	
20-225-14	6,0	



Hartmann Nasentamponadezange
Hartmann nasal dressing forceps

Art.-Nr./No.	Größe / Size (cm)	
20-200-16	16	fein / delicate
20-200-20	20	



Wigand Polypen-Fasszange, 60° aufgebogen, 11,5 cm
Wigand polyp-grasping forceps, 60° angled, 11.5 cm

20-236-00



Strümpel-Voss Nasenzange, 45°, 11,5 cm
Strümpel-Voss nasal forceps, 45°, 11.5 cm

20-238-00



03 Septum-Instrumente

Septum Instruments

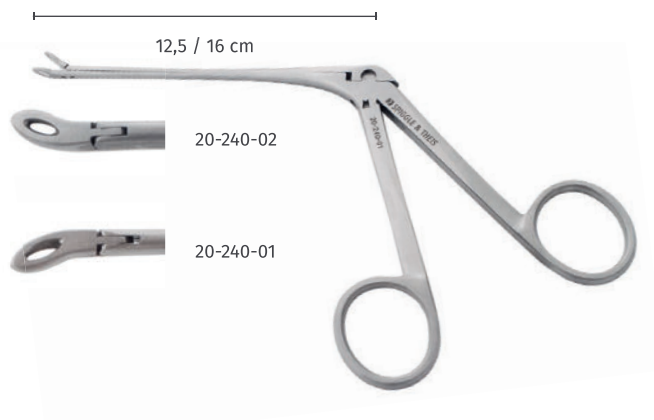

Blakesley Nasenzange / Blakesley nasal forceps

Art.-Nr./No.	Größe / Size (cm)	Winkel / Angle
20-240-01	12,5	links gebogen / curved left
20-240-02	12,5	rechts gebogen / curved right
20-240-11	16,0	links gebogen / curved left
20-240-12	16,0	rechts gebogen / curved right

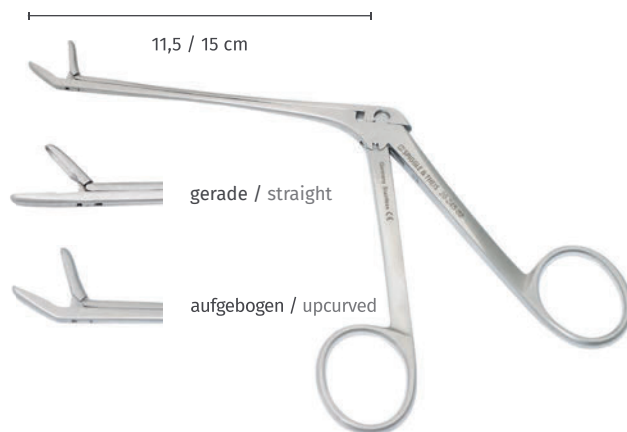

Takahashi Nasenzange / Takahashi nasal forceps

Art.-Nr. Art.-No.	Länge Length (cm)	Größe Size (mm)	Winkel Angle
20-245-01	11,5	2,5	gerade / straight
20-245-11	15,0	2,5	gerade / straight
20-246-01	11,5	4,0	gerade / straight
20-245-02	11,5	2,5	30° aufgebogen 30° curved upwards
20-245-12	15,0	2,5	30° aufgebogen 30° curved upwards
20-246-02	11,5	4,0	30° aufgebogen 30° curved upwards

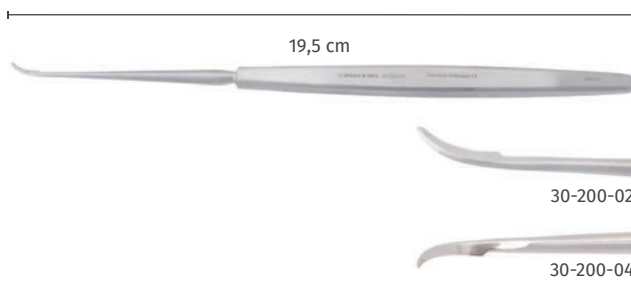

Sichelmesser, gerader Schaft, 19,5 cm

Sickle knife, straight shaft, 19.5 cm

Art.-Nr./No.	Beschreibung / Description
30-200-01	spitz / pointed
30-200-02	abgerundet / rounded
30-200-03	links gebogen, spitz curved left, pointed
30-200-04	rechts gebogen, spitz curved right, pointed

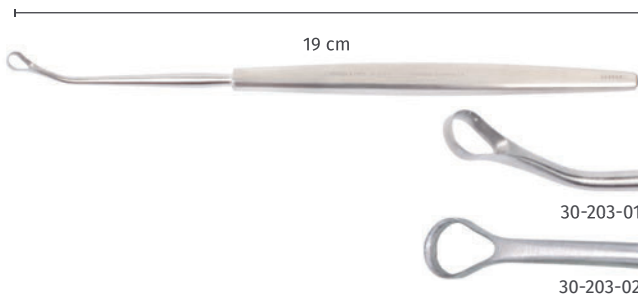

Antrum-Kürette, gerader Schaft, 19 cm

Antrum curette, straight shaft, 19 cm

Art.-Nr./No.	Beschreibung / Description
30-203-01	vorwärts schneidend / forward cutting
30-203-02	rückwärts schneidend / backward cutting



Antrum-Löffel, oval, 7,0 x 10,5 mm, gebogen, 19,5 cm

Antrum curette, oval, 7.0 x 10.5 mm, curved, 19.5 cm

30-205-01



Antrum-Löffel, längsoval, 45° gewinkelt, 19,5 cm

Antrum curette, oval, 45° angled, 19.5 cm

Art.-Nr./No.	Beschreibung / Description
30-205-02	klein (2,5 x 6,0 mm) / small
30-205-03	groß (4,0 x 9,0 mm) / large



04 FESS-Instrumentarium

FESS Instruments

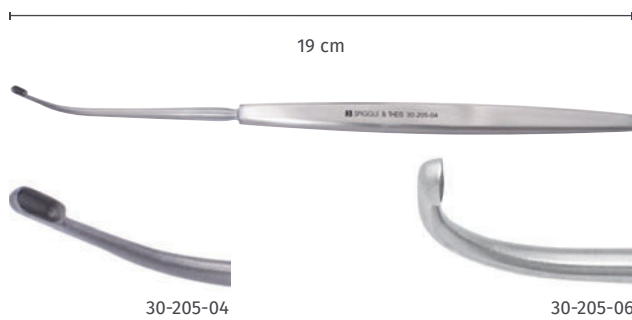

Stirnhöhlen-Löffel, gerader Schaft, längsoval, Löffelgröße 2,5 x 6,0 mm, 19 cm
Frontal sinus curette, straight shaft, oval, tip size 2.5 x 6.0 mm, 19 cm

Art.-Nr./No.	Winkel / Angle
30-205-04	55° aufgebogen / 55° curved upwards
30-205-06	90° aufgebogen / 90° curved upwards
30-205-70	70° aufgebogen / 70° curved upwards



Wigand Stirnhöhlenraspel, 21 cm
Wigand frontal sinus rasp, 21 cm

30-209-01

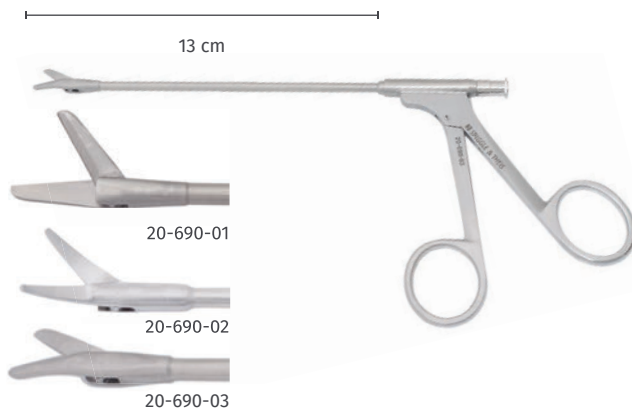

Conchotomie Schere, gezahnt, Rohrschaft, mit Spülkanal, 13 cm
Nasal conchotomy scissors, serrated, tubular model, with irrigation channel, 13 cm

Art.-Nr./No.	Beschreibung / Description
20-690-01	gerade / straight
20-690-02	links gebogen / curved left
20-690-03	rechts gebogen / curved right



Weber Nasenschere, extra fein, gerade, mit Spülkanal, 10,5 cm
Weber nasal scissors, very fine, straight, with irrigation channel, 10.5 cm

20-691-01



Diese Scheren eignen sich hervorragend zur Eröffnung von Siebbeinzellen unter weitgehender Erhaltung der Schleimhaut.

Ein „Anstechen“ und nicht „Vorschieben“ der Siebbeinschleimhaut ist mit der extra feinen und verlängerten unteren Schneide gewährleistet.

Dr. med. Hohenhorst,
Chefarzt der HNO Abteilung des
Alfried Krupp Krankenhauses in Essen

These scissors are ideally suited for opening ethmoidal cells while keeping the mucous membrane largely intact.

The super-fine and elongated lower blade ensures that the mucous membrane of the ethmoid bone is “punctured” and not “pushed forward.”

Dr. med. Hohenhorst,
Chief physician of the ENT department
of the Alfred Krupp Clinic, Essen, Germany

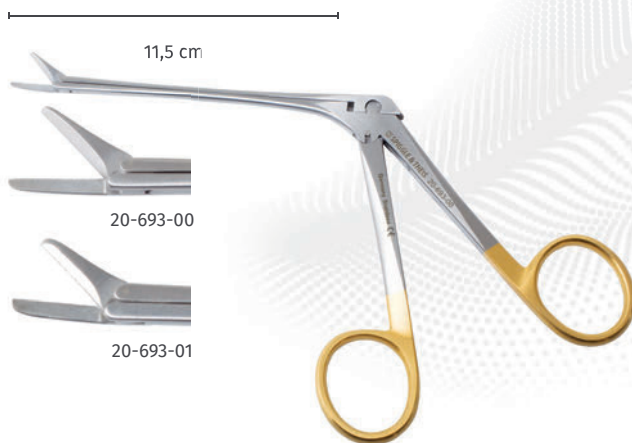

Conchotomie Schere, 11,5 cm

Nasal conchotomy scissors, 11.5 cm

Art.-Nr./No.	Beschreibung / Description
20-693-00	standard / standard
20-693-01	extra fein / extra delicate
20-693-02	extra fein, spitz, untere Schneide verlängert extra delicate, pointed, lower blade longer



Stirnhöhle sonde, doppelseitig, leicht gebogen, 20,5 cm

Frontal sinus probe, double ended, slightly curved, 20.5 cm

30-207-01



Kieferhöhlen sonde, doppelseitig, 19 cm

Maxillary sinus probe, double ended, 19 cm

30-207-02

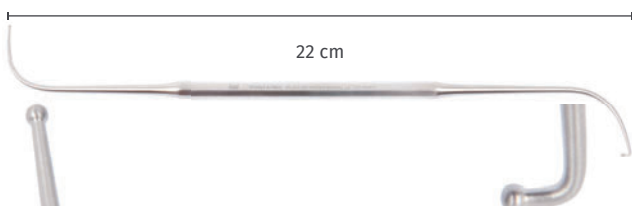

Stirnhöhle sonde, doppelseitig, stark gebogen, 22 cm

Frontal sinus probe, double ended, strongly curved, 22 cm

30-207-03



04 FESS-Instrumentarium

FESS Instruments

SPIGGLE & THEIS Medizintechnik GmbH legt besonderen Wert darauf, dass alle Instrumente und Endoskope nach validierten Verfahren aufbereitet werden können. Dies bezieht sich sowohl auf die Reinigung als auch auf die Sterilisation der Produkte. Innovative Lösungen wie Spülkanäle in Rohrschaft-Instrumenten oder Zerlegbarkeit von Zangen und Stanzen belegen unsere Vorreiterrolle in diesem Bereich.

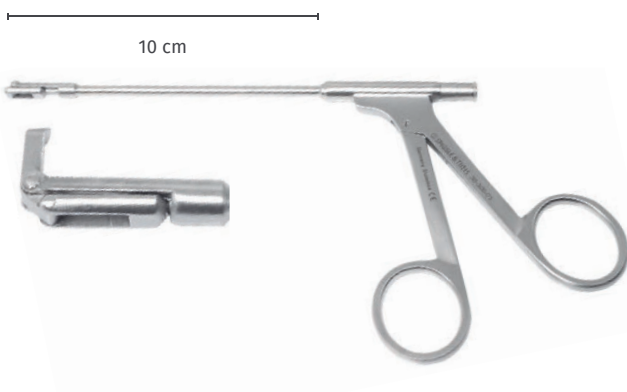

It is of special importance to SPIGGLE & THEIS Medizintechnik GmbH that all our instruments and endoscopes can be processed in accordance with accepted validation methods, regarding both the cleaning and the sterilization of the products. Our pioneering position in this field is supported by such innovative solutions as irrigation channels in tube-shaft instruments as well as detachable slide-bar instruments for forceps and punches.

Antrumstanze, rückwärts schneidend, 2,5 mm, mit Spülkanal, 10 cm

Antrum punch, backward cutting, 2.5 mm, with irrigation channel, 10 cm

Art.-Nr./No.	Beschreibung / Description
30-300-01	Gerade schneidend / straight cutting
30-300-02	Links schneidend / left cutting
30-300-03	Rechts schneidend / right cutting

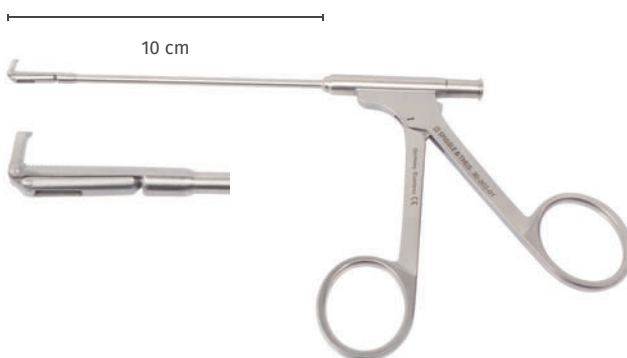

Antrumstanze, rückwärts schneidend, gerade, 1,5 mm, 10 cm, mit Spülkanal

Antrum punch, backward cutting, straight, 1.5 mm, 10 cm, with irrigation channel

Art.-Nr./No.	Beschreibung / Description
30-302-01	Gerade schneidend / straight cutting
30-302-02	Links schneidend / left cutting
30-302-03	Rechts schneidend / right cutting

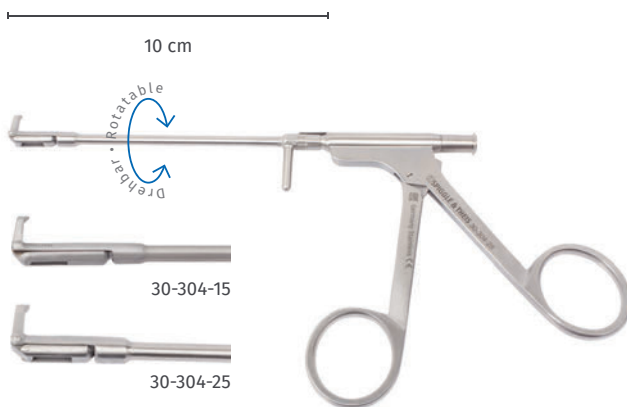

Antrumstanze, rückwärts schneidend, drehbar, 2,5 mm, mit Spülkanal, 10 cm
Antrum punch, backward cutting, rotatable, 2.5 mm, with irrigation channel, 10 cm

Art.-Nr./No.	Größe / Size (mm)
30-304-15	1,5
30-304-25	2,5

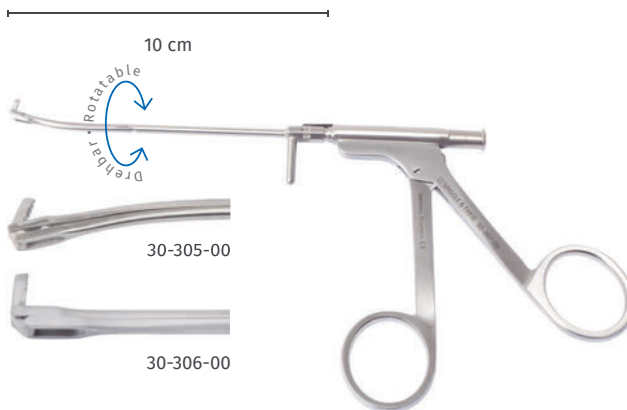

Tobey Mikro-Antrumstanze, rückwärts schneidend, drehbar, mit Spülkanal, 10 cm
Tobey micro antrum punch, backward cutting, rotatable, with irrigation channel, 10 cm

Art.-Nr./No.	Beschreibung / Description
30-305-00	Schaft abwärts gebogen / downwards curved shaft
30-306-00	gerader Schaft / straight shaft
30-307-00	Schaft aufwärts gebogen / upwards curved shaft

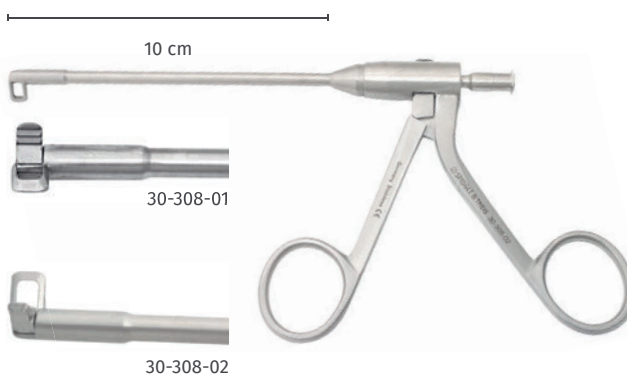

Antrumstanze, seitwärts schneidend, 10 cm
Antrum punch, sideways cutting, 10 cm

Art.-Nr./No.	Beschreibung / Description
30-308-01	Links schneidend / left cutting
30-308-02	Rechts schneidend / right cutting



04 FESS-Instrumentarium

FESS Instruments

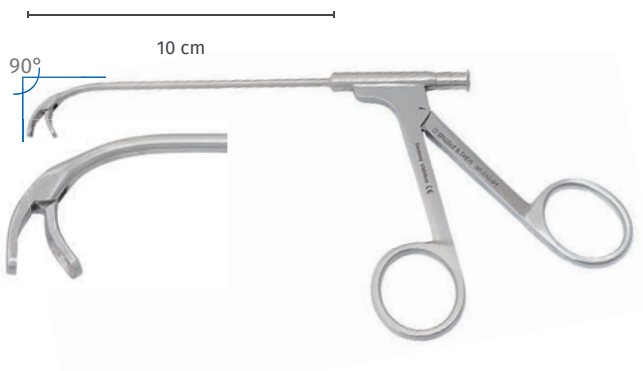

Kieferhöhlen Polypen-Fasszange, rückwärts öffnend, mit Spülkanal, 10 cm
Antrum polyp grasping forceps, retrograde opening, with irrigation channel, 10 cm

30-310-01

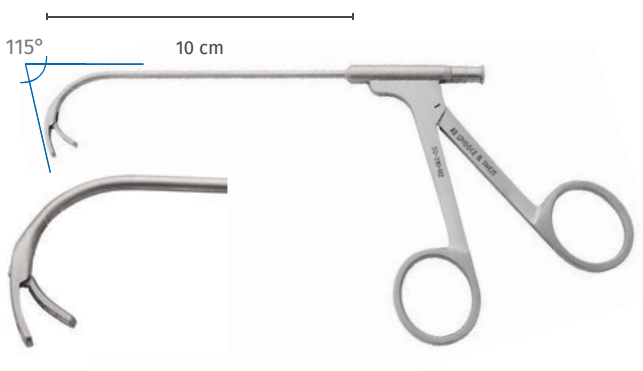

Kieferhöhlen Polypen-Fasszange, rückwärts öffnend, extra langer Schaftbogen, mit Spülkanal, 10 cm
Antrum polyp grasping forceps, retrograde opening, extra long shaft curve, with irrigation channel, 10 cm

30-310-02

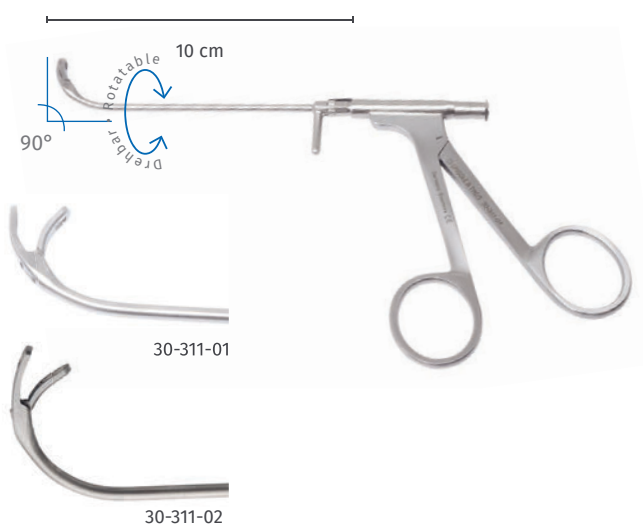





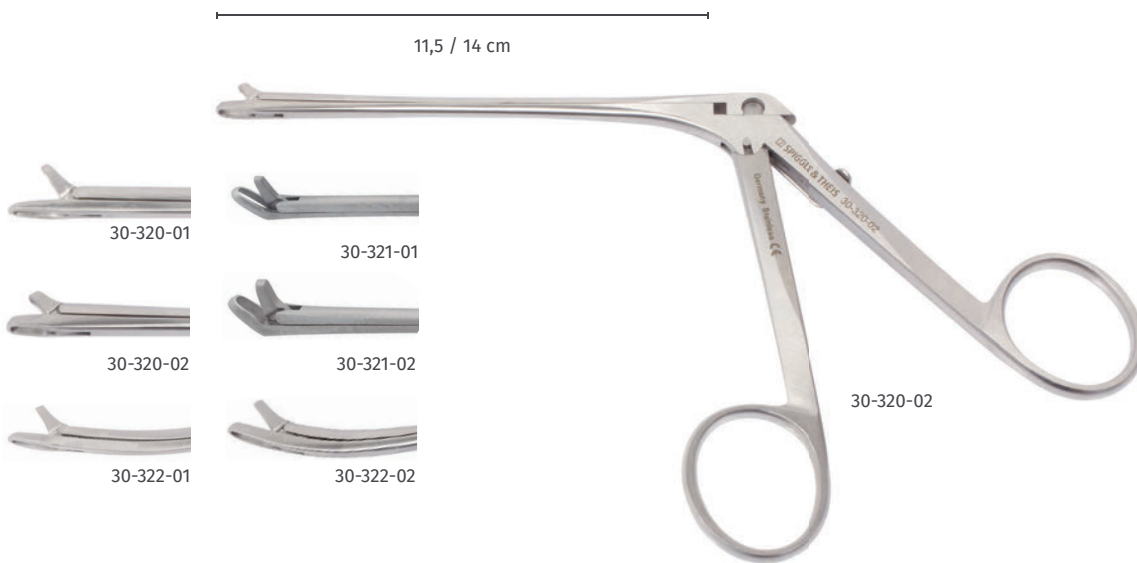

Kieferhöhlen Polypen-Fasszange, rückwärts öffnend, drehbar, 10 cm
Antrum polyp grasping forceps, retrograde opening, rotatable, 10 cm

Art.-Nr./No.	Beschreibung / Description
30-311-01	normaler Schaft / normal shaft
30-311-02	extra langer Schaftbogen / extra long shaft curve



Durchschneidende Nasenzange / Throughcutting nasal forceps

Art.-Nr. Art.-No.	Größe Size (mm)	Länge Length (cm)		Winkel Angle
30-320-01	5,0 x 1,5	14,0		gerade / straight
30-320-02	6,5 x 2,5	11,5		gerade / straight
30-321-01	5,0 x 1,5	14,0		60° gewinkelt / 60° angled
30-321-02	6,5 x 2,5	11,5		60° gewinkelt / 60° angled
30-322-01	5,0 x 1,5	14,0		aufgebogen / curved upwards
30-322-02	8,0 x 3,0	14,0		aufgebogen / curved upwards

Vorteile / Advantages

Stumpfes Ende = Dura-Schutz
Blunt end = dura protection



Löffelzange, aufgebogen, kräftig, 6,5 x 2,5 mm, 14 cm
Cup Forceps, curved upwards, robust, 6.5 x 2.5 mm, 14 cm

30-328-01



04 FESS-Instrumentarium

FESS Instruments

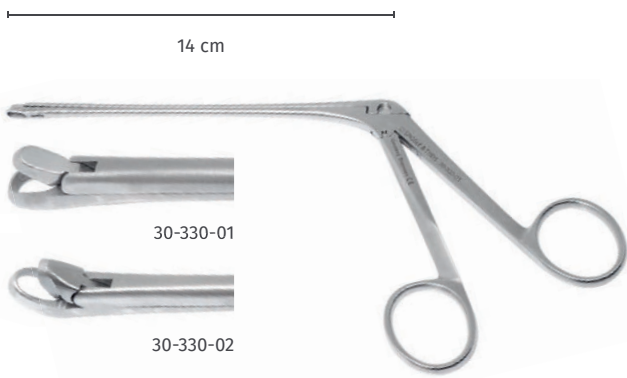

Wigand durchschneidende Zange, flach, abgerundet, 14 cm
Wigand throughcutting forceps, flat, rounded, 14 cm

Art.-Nr. Art.-No.	Größe Size (mm)	Winkel Angle
30-330-01	4,0 x 3,0	gerade / straight
30-330-02	4,0 x 3,0	45° aufgewinkelt / 45° angled



Herberhold cranial durchschneidende Zange, flach
Herberhold cranial throughcutting forceps, flat

Art.-Nr. Art.-No.	Größe Size (mm)	Länge Length (cm)	Winkel Angle
30-332-01	6,0 x 2,0	14	gerade / straight
30-332-02	11,5 x 2,5	14	gerade / straight
30-333-01	6,0 x 2,0	14	60° aufgebogen 60° curved upwards
30-333-02	11,5 x 2,5	14	60° aufgebogen 60° curved upwards

Vorteile:

- Stanzmaterial wird nach oben ausgeworfen
- Unterer Block (feststehend) kann als Trokar verwendet werden
- Zahnung verhindert Wegrutschen

Advantages:

- punched material is ejected upwards
- Lower block (fixed) can be used as trocar
- Serration prevents slipping

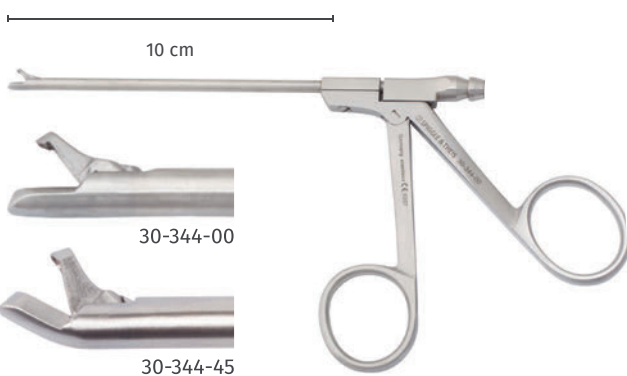

Durchschneidende Saugzange, 10 cm
Throughcutting suction forceps, 10 cm

Art.-Nr./No.	Winkel / Angle
30-344-00	gerade / straight
30-344-45	30° aufgewinkelt / 30° angled

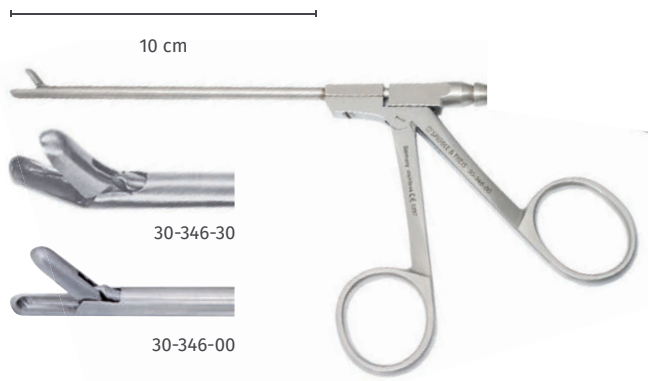

Takahashi Nasenzange mit Saugkanal, 10 cm
Takahashi suction forceps with suction tube, 10 cm

Art.-Nr./No.	Winkel / Angle
30-346-00	gerade / straight
30-346-30	30° aufgewinkelt / 30° angled

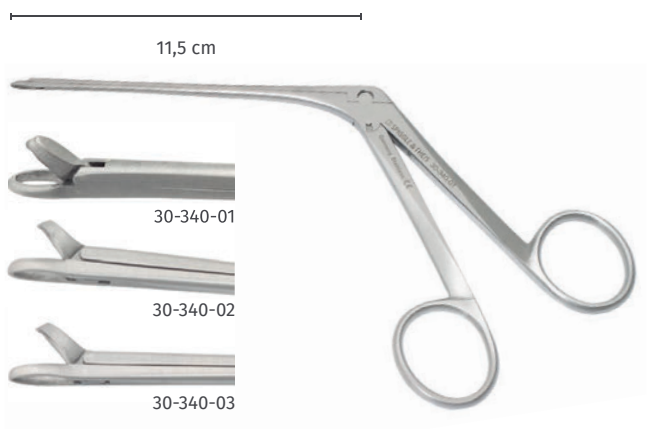

Blakesley Nasenzange, durchschneidend, gerade, 11,5 cm
Blakesley nasal forceps, throughcutting, straight, 11.5 cm

Art.-Nr./No.	Größe / Size (mm)
30-340-01	5,0 x 2,0
30-340-02	6,0 x 2,5
30-340-03	7,0 x 3,0



Blakesley Nasenzange, durchschneidend, 45° aufgebogen, 11,5 cm
Blakesley nasal forceps, throughcutting, 45° curved upwards, 11.5 cm

Art.-Nr./No.	Größe / Size (mm)
30-342-01	5,0 x 2,0
30-342-02	6,0 x 2,5
30-342-03	8,0 x 3,0



04 FESS-Instrumentarium

FESS Instruments

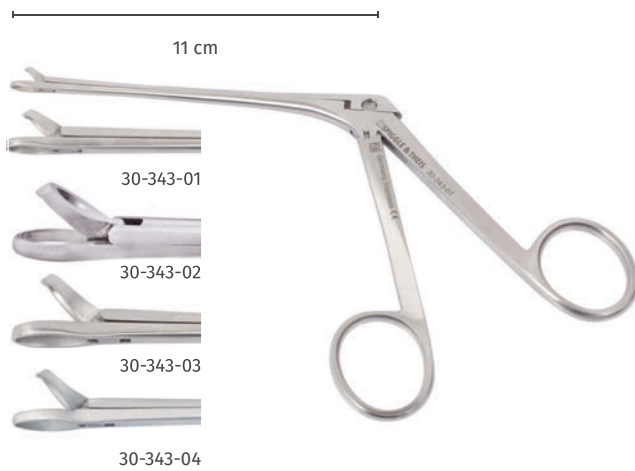

Blakesley Nasenzange, durchschneidend, gerade, 11 cm

Blakesley nasal forceps, throughcutting, straight, 11 cm

Art.-Nr./No.	Größe / Size (mm)	Größe / Size
30-343-01	6,0 x 3,0	1
30-343-02	8,0 x 3,5	2
30-343-03	8,0 x 4,0	3
30-343-04	10,0 x 4,8	4

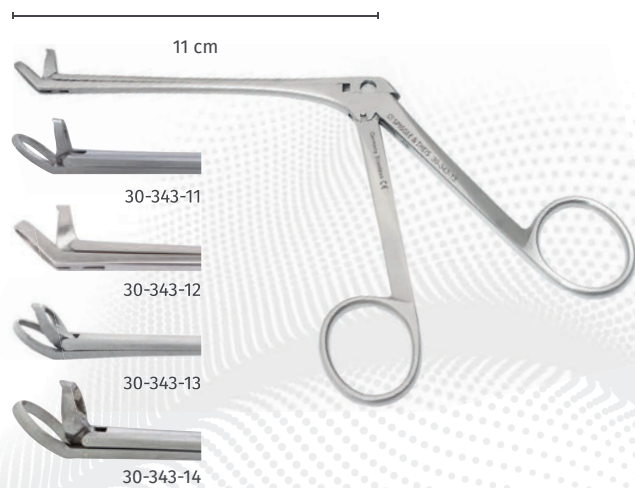

Blakesley Nasenzange, durchschneidend, 45° aufgebogen, 11 cm

Blakesley nasal forceps, throughcutting, 45° curved upwards, 11 cm

Art.-Nr./No.	Größe / Size (mm)	Größe / Size
30-343-11	8,0 x 3,0	1
30-343-12	8,0 x 3,5	2
30-343-13	9,0 x 4,2	3
30-343-14	10,0 x 4,8	4

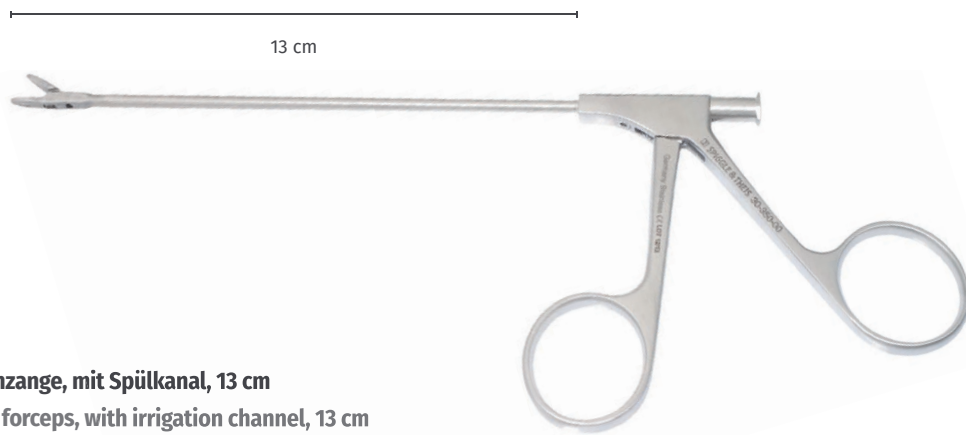
**Blakesley Nasenzange, mit Spülkanal, 13 cm****Blakesley nasal forceps, with irrigation channel, 13 cm**

Art.-Nr./No.	Größe / Size (mm)	Winkel / Angle
30-350-00	3,0	gerade / straight
30-350-01	3,5	gerade / straight
30-350-02	4,0	gerade / straight
30-350-03	5,0	gerade / straight
30-352-00	3,0	45° aufgebogen / 45° curved upwards
30-352-01	3,5	45° aufgebogen / 45° curved upwards
30-352-02	4,0	45° aufgebogen / 45° curved upwards
30-354-01	3,5	90° aufgebogen / 90° curved upwards
30-354-02	4,0	90° aufgebogen / 90° curved upwards
30-358-00	3,0	gerade, durchschneidend / straight, throughcutting
30-358-01	3,5	gerade, durchschneidend / straight, throughcutting
30-358-02	4,0	gerade, durchschneidend / straight, throughcutting
30-360-00	3,0	45° aufgebogen, durchschneidend / 45° curved upwards, throughcutting
30-360-01	3,5	45° aufgebogen, durchschneidend / 45° curved upwards, throughcutting
30-360-02	4,0	45° aufgebogen, durchschneidend / 45° curved upwards, throughcutting



04 FESS-Instrumentarium

FESS Instruments



Grünwald Rohrschaftzange, durchschneidend, 13 cm, mit Spülkanal
Grünwald tubular forceps, throughcutting, 13 cm, with irrigation channel

Art.-Nr. Art.-No.	Größe Size (mm)	Winkel Angle
30-370-15	1,5	gerade, Schaft gerade / straight, straight shaft
30-370-20	2,0	gerade, Schaft gerade / straight, straight shaft
30-370-25	2,5	gerade, Schaft gerade / straight, straight shaft
30-370-30	3,0	gerade, Schaft gerade / straight, straight shaft
30-371-15	1,5	45°, Schaft gerade / 45°, straight shaft
30-371-20	2,0	45°, Schaft gerade / 45°, straight shaft
30-371-25	2,5	45°, Schaft gerade / 45°, straight shaft
30-371-30	3,0	45°, Schaft gerade / 45°, straight shaft
30-372-15	1,5	gerade, Schaft 30° aufgebogen / straight, shaft 30° curved upwards
30-372-20	2,0	gerade, Schaft 30° aufgebogen / straight, shaft 30° curved upwards
30-372-25	2,5	gerade, Schaft 30° aufgebogen / straight, shaft 30° curved upwards
30-373-15	1,5	45°, Schaft 30° aufgebogen / 45°, shaft 30° curved upwards
30-373-20	2,0	45°, Schaft 30° aufgebogen / 45°, shaft 30° curved upwards
30-373-25	2,5	45°, Schaft 30° aufgebogen / 45°, shaft 30° curved upwards
30-374-20	2,0	gerade öffnend, Schaft 70° aufgebogen / straight opening, shaft 70° curved upwards
30-375-20	2,0	seitl. rechts öffnend, Schaft 70° aufgebogen / right side opening, shaft 70° curved upwards
30-376-20	2,0	seitl. links öffnend, Schaft 70° aufgebogen / left side opening, shaft 70° curved upwards



05 Dieler Bipolare Koagulationszangen

Dieler bipolar coagulation forceps



Prof. Dr. med. Ralf Dieler
Leitender Arzt, HNO-Abteilung,
Rotkreuzklinik Würzburg

Prof. Dr. med. Ralf Dieler
ENT-specialist
Rotkreuzklinik Würzburg, Germany

Um den Gewebeschaden durch Koagulation arterieller Blutungen bei chirurgischen Eingriffen in der Nasennebenhöhle (A. ethmoidalis post. oder der A. sphenopalatina) möglichst gering zu halten, sind bipolare Zangen zu bevorzugen. Gegenüber der monopolen Technik wird hierbei bis zu 30% weniger Leistung benötigt. Darüber hinaus entstehen keine relevanten elektrischen Interferenzen mit elektronischen Implantaten (z.B. Herzschrittmacher, Cochlear Implant) oder mit Geräten, die am Patienten angeschlossen sind (z.B. EKG, EEG).

Die Dieler Koagulations-Fasszange ist 30° gewinkelt, gefenestert und 360° drehbar, so dass ein gezieltes Fassen der genannten Gefäße möglich ist. Für eine bessere Sicht im Situs können mit Hilfe eines Einmal-Schlauchsets Blut und Schmauch gleichzeitig abgesaugt werden.

Bipolar forceps should be used in order to minimize tissue damage caused by coagulation in arterial bleeding (post ethmoid artery or the sphenopalatine artery) during paranasal sinus surgery. Up to 30% less power is required in comparison with monopolar technology. A further advantage is that there will be no relevant electrical interference with electrical implants (e.g. cardiac pacemaker, cochlear implant) or bodily function supporting devices (e.g. EKG, EEG).

The Dieler bipolar coagulation forceps is 30° angled, fenestrated and 360° rotatable. This allows a controlled grasping of the mentioned vessels. For better viewing conditions in situs, the disposable attachable suction tube effectively evacuates blood and smoke.

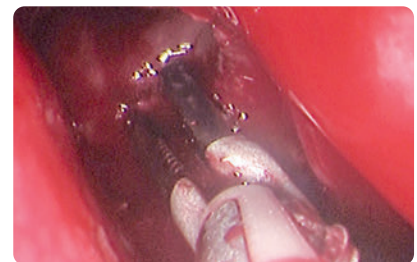

05 Dieler Bipolare Koagulationszangen

Dieler bipolar coagulation forceps



Basis-Komponenten / Basic components



Ringgriff für Dieler Koagulationszange
Ring handle for Dieler coagulation forceps

80-090-00



Schaft für Dieler Koagulationszange, 3 mm, 15 cm
Shaft for Dieler coagulation forceps, 3 mm, 15 cm

80-090-01



Fasszange für Dieler Koagulationszange, 30° gewinkelt, gefenstert, 15 cm

Grasping forceps for Dieler coagulation forceps, 30° angled, fenestrated, 15 cm

80-090-04





05 Dieler Bipolare Koagulationszangen

Dieler bipolar coagulation forceps

Aufsätze / Add-ons



Fasszange für Dieler Koagulationszange, gerade, gefenstert, 15 cm
Grasping forceps for Dieler coagulation forceps, straight, fenestrated, 15 cm

80-090-03



Löffelzange für Dieler Koagulationszange, aufgebogen, 15 cm
Spoon forceps for Dieler coagulation forceps, upcurved, 15 cm

Art.-Nr./No.	Größe / Size (mm)
80-090-05	2,0
80-090-06	2,7



Zange für Dieler Koagulationszange, gerieft, 15 cm
Forceps for Dieler coagulation forceps, serrated, 15 cm

Art.-Nr.	Beschreibung / Description
80-090-07	aufgebogen/upcurved
80-090-08	aufgewinkelt/upangled

Flamingo-Zange für Dieler Koagulationszange, vertikal, 15 cm
Flamingo forceps for Dieler coagulation forceps, vertical, 15 cm



Art.-Nr./No.	Winkel / Angle	Länge / Length (mm)
80-090-09	15°	0,7
80-090-10	15°	1,2
80-090-11	15°	2,0
80-090-12	30°	0,7
80-090-13	30°	1,2
80-090-14	30°	2,0
80-090-15	45°	0,7
80-090-16	45°	1,2
80-090-17	45°	2,0



05 Dieler Bipolare Koagulationszangen

Dieler bipolar coagulation forceps



Saugschlauch, steril, 10 Stück/Box
Suction tube, sterile, 10 pieces/box

80-090-02



Bipolares Anschlusskabel, für Scheren/Zangen,
3 m lang, geräteseitig, passend für:

Bipolar connecting cable for scissors/forceps,
3 m, unit-side, compatible with:
Sutter/Martin/ Berchtold/Aesculap/Integra

80-320-30



Bipolares Anschlusskabel, für Scheren/Zangen,
3 m lang, geräteseitig, passend für:

Bipolar connecting cable for scissors/forceps,
3 m, unit-side, compatible with:
Valleylab

80-321-30



Bipolares Anschlusskabel, für Scheren/Zangen,
3 m lang, geräteseitig, passend für:

Bipolar connecting cable for scissors/forceps,
3 m, unit-side, compatible with:
Erbe/Storz/Wolf

80-322-30



Bipolares Anschlusskabel für Scheren/Zangen,
4 m lang, passend für:

Bipolar connecting cable for scissors/forceps,
4 m, compatible with:
U20

80-324-40

06 Stirnhöhlen- und Keilbeinhöhlen-Instrumente

Frontal and Sphenoidal Instruments

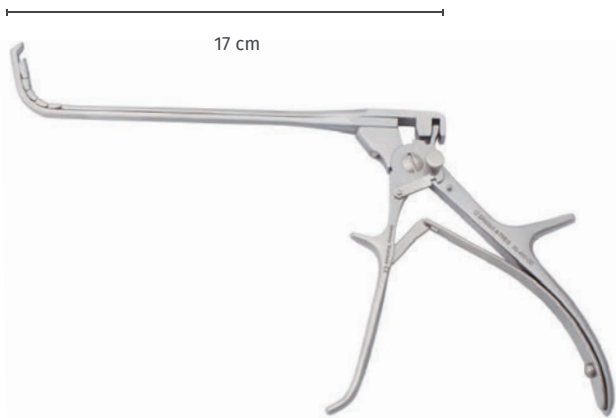

Stirnhöhlenstanze, 70° aufgebogen, 17 cm

Frontal sinus punch, 70° curved upwards, 17 cm

Art.-Nr./No.	Größe / Size (mm)
30-400-00	3
30-400-01	2

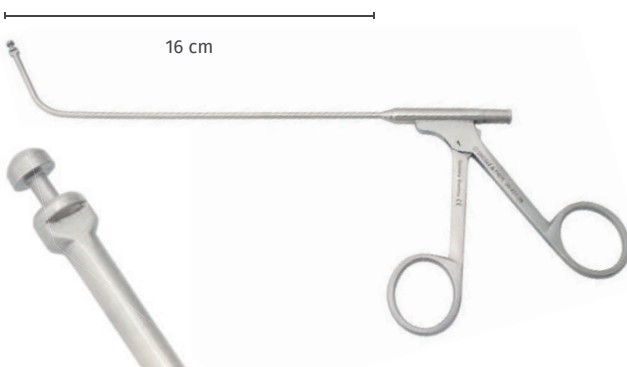

Rundkopfstanze für Stirnhöhle, mit Spülkanal, 16 cm

Frontal sinus circular punch, with irrigation channel, 16 cm

Art.-Nr./No.	Größe / Size (mm)	Winkel / Angle
30-421-35	3,5	60°
30-421-45	4,5	60°



Rundkopfstanze für Stirnhöhle,

eiförmig, 90° Schnitt, mit Spülkanal, 16 cm

Frontal sinus circular punch, egg-form,

90° cutting, with irrigation channel, 16 cm

Art.-Nr./No.	Größe / Size (mm)	Winkel / Angle
30-428-35	3,5	60°
30-428-45	4,5	60°



06 Stirnhöhlen- und Keilbeinhöhlen-Instrumente

Frontal and Sphenoidal Instruments

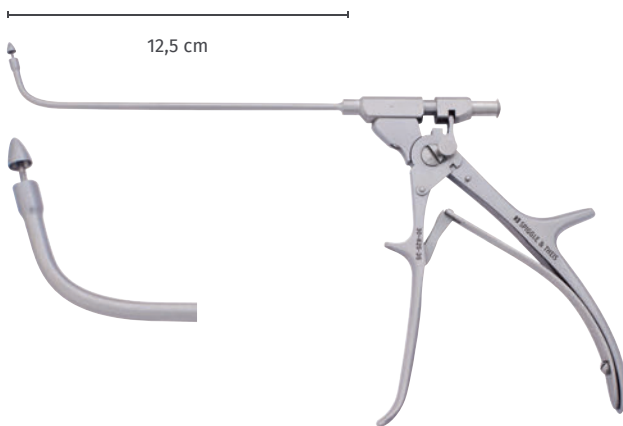

**Stirnhöhlen-Stanze, aufgebogen,
stumpfes Ende, mit Spülkanal, 12,5 cm**
Frontal sinus punch, curved upwards,
blunt end, with irrigation channel, 12.5 cm

Art.-Nr./No. Größe / Size (mm)

30-425-35	3,5
30-425-45	4,5

Vorteile / Advantages:

- Rückwärts schneidend / Backwards cutting
- Geringer Kraftaufwand / Little force required
- Besonders leichtgängig / Runs smoothly

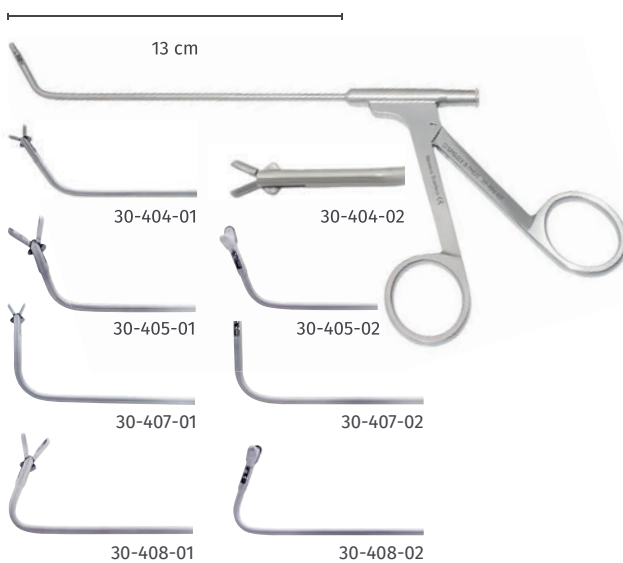

Stirnhöhlen Löffelzange, oval, mit Spülkanal, 13 cm
Frontal sinus forceps, oval cups, with irrigation channel, 13 cm

Art.-Nr./No. Größe / Size (mm) Winkel / Angle

30-404-01	2	55°, vertikal / vertical
30-404-02	2	55°, horizontal
30-405-01	4	70°, vertikal / vertical
30-405-02	4	70°, horizontal
30-405-11	4	55°, vertikal / vertical
30-405-12	4	55°, horizontal
30-407-01	2	90°, vertikal / vertical
30-407-02	2	90°, horizontal
30-408-01	4	110°, vertikal / vertical
30-408-02	4	110°, horizontal

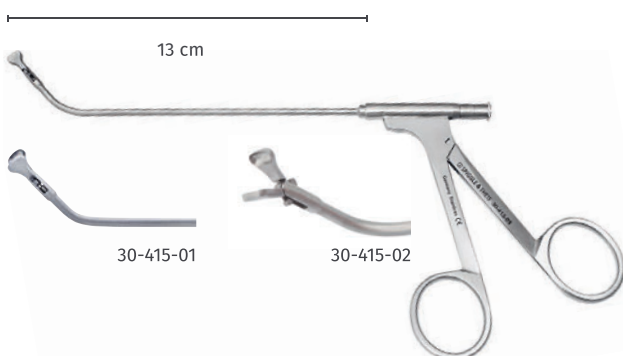

Binner Polypenfasszange, 3 mm, mit Spülkanal, 13 cm
Binner polyp forceps, 3 mm, with irrigation channel, 13 cm

Art.-Nr./No. Winkel / Angle

30-415-01	45°, horizontal
30-415-02	80°, horizontal

06 Stirnhöhlen- und Keilbeinhöhlen-Instrumente

Frontal and Sphenoidal Instruments

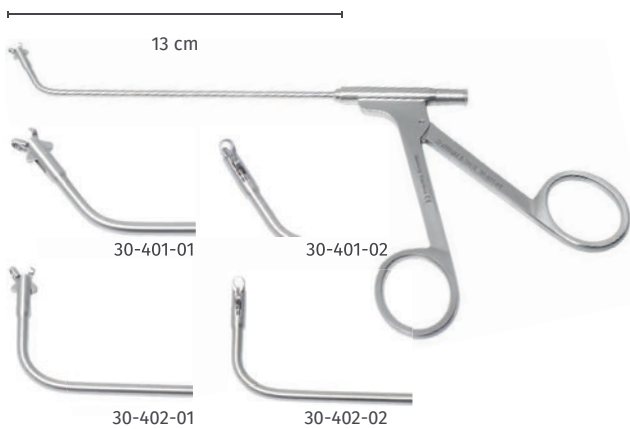

Stirnhöhlenzange, durchschneidend, 2 mm, mit Spülkanal

Frontal sinus forceps, throughcutting, 2 mm, with irrigation channel

Art.-Nr./No.	Größe / Size (cm)	Winkel / Angle
30-401-01	13	55°, vertikal / vertical
30-401-02	13	55°, horizontal
30-402-01	13	90°, vertikal / vertical
30-402-02	13	90°, horizontal

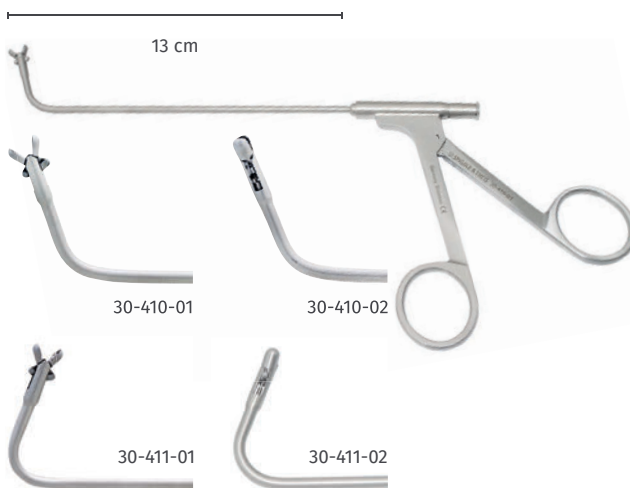

Stirnhöhlen Biopsiezange, 3 mm, mit Spülkanal, 13 cm

Frontal sinus biopsy forceps, 3 mm, with irrigation channel, 13 cm

Art.-Nr./No.	Winkel / Angle
30-410-01	70°, vertikal / vertical
30-410-02	70°, horizontal
30-411-01	110°, vertikal / vertical
30-411-02	110°, horizontal



Rundkopfstanze für Keilbeinhöhle,

eiförmig, 60° Schnitt, mit Spülkanal, 16 cm

Sphenoid sinus circular punch, egg-formed, 60° cutting, with irrigation channel, 16 cm

Art.-Nr./No.	Größe / Size (mm)	Beschreibung / Description
30-429-35	3,5	gerade / straight
30-429-45	4,5	gerade / straight



06 Stirnhöhlen- und Keilbeinhöhlen-Instrumente

Frontal and Sphenoidal Instruments

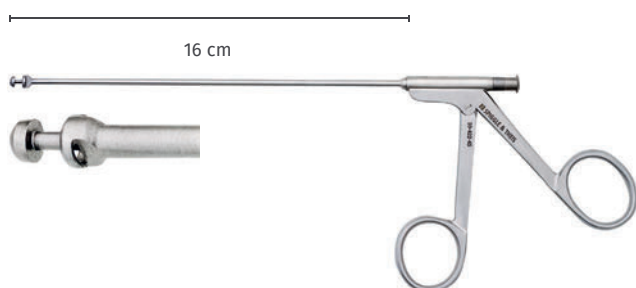

Rundkopfstanze für Keilbeinhöhle, mit Spülkanal, 16 cm
Sphenoid sinus circular punch, with irrigation channel, 16 cm

Art.-Nr./No.	Größe / Size (mm)	Winkel / Angle
30-422-35	3,5	0°
30-422-45	4,5	0°

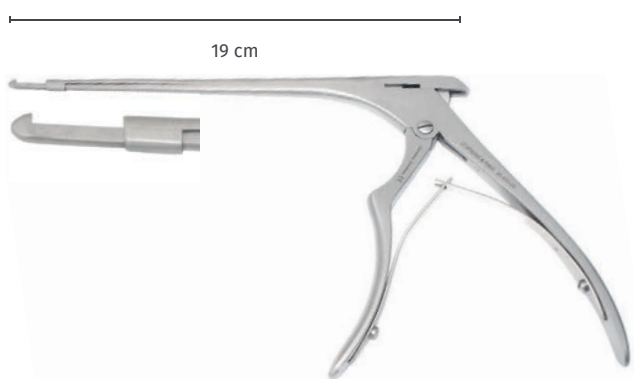

Knochenstanze mit Reservoir, 2 mm, mit Mandrin, 19 cm
Antrum punch with collector, 2 mm, with stylet, 19 cm

30-450-20



Mandrin zum Entfernen von Knochenmaterial aus Knochenstanzen
Stylet for removal of bone residue from antrum punch

30-450-90

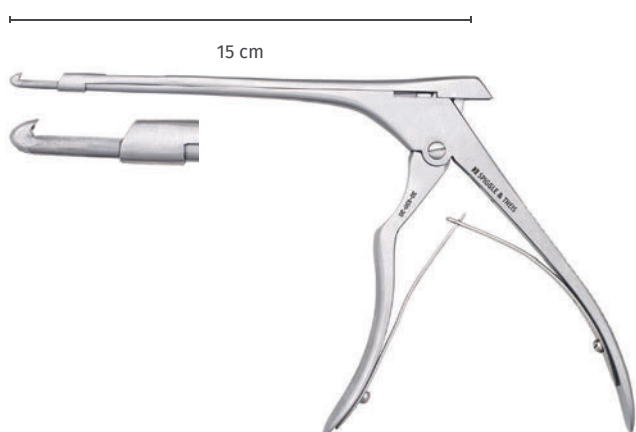

Knochenstanze mit Reservoir, 3 mm, mit Mandrin, 15 cm
Antrum punch with collector, 3 mm, with stylet, 15 cm

30-450-30

06 Stirnhöhlen- und Keilbeinhöhlen-Instrumente

Frontal and Sphenoidal Instruments

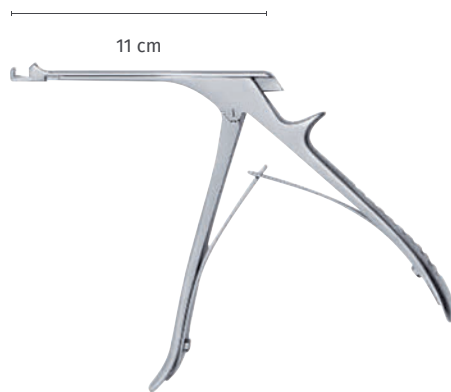

Beyer Knochenstanze für Kinder, 90°, 2 mm, 11 cm
Beyer antrum punch for children, 90°, 2 mm, 11 cm

30-457-15

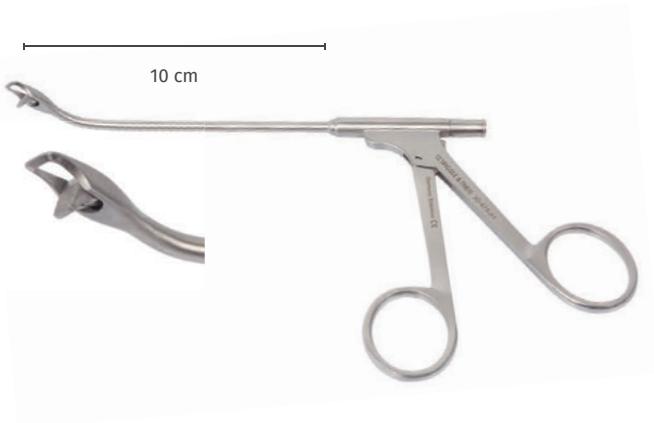

Schwager Stanze für den Orbitaboden, mit Spülkanal, 45°, 3,5 mm, 10 cm
Schwager punch for orbita floor, with irrigation channel, 45°, 3.5 mm, 10 cm

Art.-Nr./No.	Beschreibung / Description
30-475-01	links / left
30-475-02	rechts / right

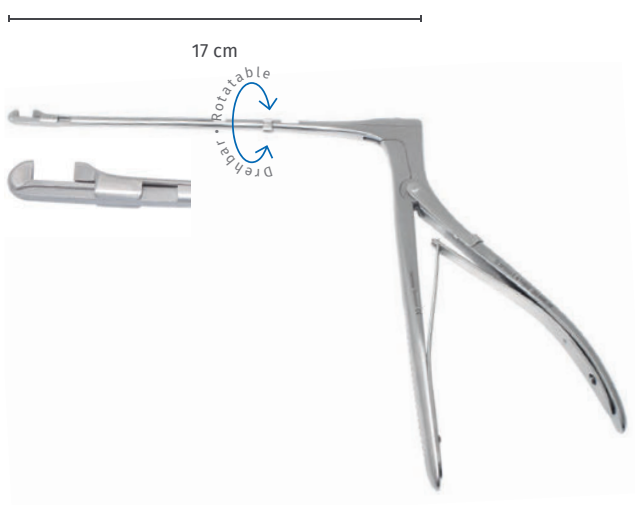

Hajek-Kofler Keilbeinstanze, aufeinander schneidend, drehbar, 3 mm, 17 cm, zerlegbar
Hajek-Kofler sphenoid punch, rotatable, 3 mm, 17 cm, detachable

30-456-32



06 Stirnhöhlen- und Keilbeinhöhlen-Instrumente

Frontal and Sphenoidal Instruments

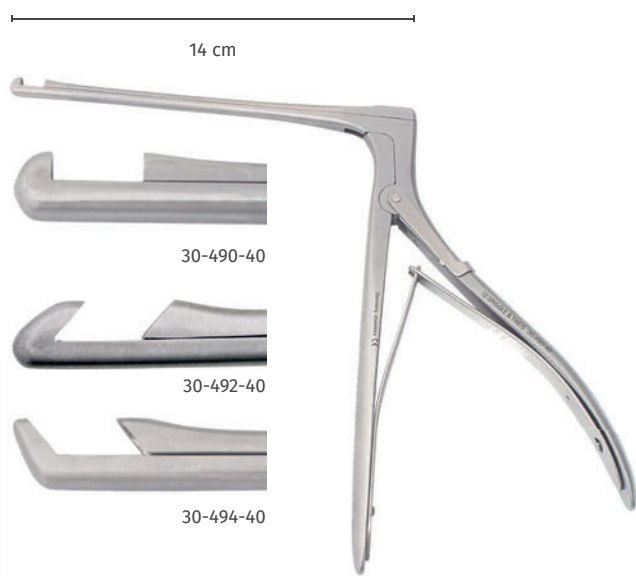

Hajek-Kofler Keilbeinstanze, aufeinander schneidend, zerlegbar, 4 mm, 14 cm

Hajek-Kofler sphenoid punch, detachable, 4 mm, 14 cm

Art.-Nr./No.	Winkel / Angle
30-490-40	90°, aufwärts / upwards
30-491-40	90°, abwärts / downwards
30-492-40	40°, aufwärts, rückwärts upwards, backwards
30-493-40	40°, abwärts, rückwärts downwards, backwards
30-494-40	40°, aufwärts, vorwärts upwards, forwards

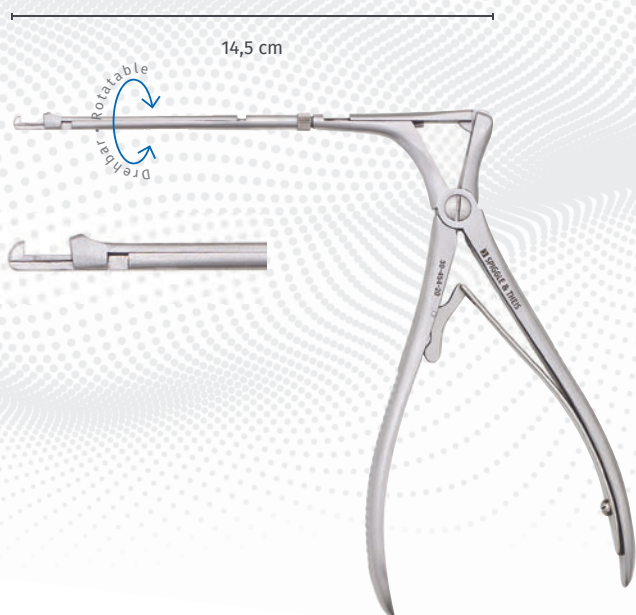

McKenty Keilbeinstanze, durchschneidend, drehbar, 2 mm, 14,5 cm

McKenty sphenoid punch, throughcutting, rotatable, 2 mm, 14.5 cm

30-454-20

06 Stirnhöhlen- und Keilbeinhöhlen-Instrumente

Frontal and Sphenoidal Instruments

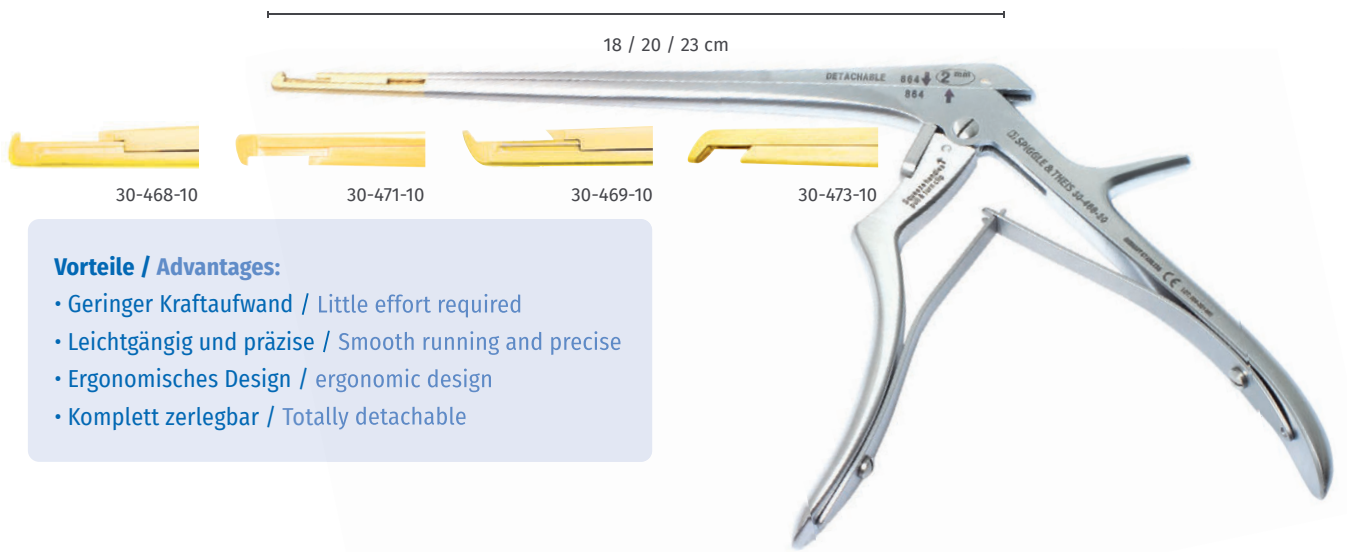

Vorteile / Advantages:

- Geringer Kraftaufwand / Little effort required
- Leichtgängig und präzise / Smooth running and precise
- Ergonomisches Design / ergonomic design
- Komplett zerlegbar / Totally detachable

Kerrison Keilbeinstanze / Kerrison sphenoid punch

Art.-Nr. Art.-No.	Größe Size (mm)	Länge Length (cm)	Winkel Angle
30-468-10	1	18	90° aufwärts / upwards
30-468-20	2	18	90° aufwärts / upwards
30-468-30	3	18	90° aufwärts / upwards
30-468-40	4	18	90° aufwärts / upwards
30-468-50	5	18	90° aufwärts / upwards
30-469-10	1	18	40° aufwärts / upwards
30-469-20	2	18	40° aufwärts / upwards
30-469-30	3	18	40° aufwärts / upwards
30-469-40	4	18	40° aufwärts / upwards
30-469-50	5	18	40° aufwärts / upwards
30-471-10	1	18	90° abwärts / downwards
30-471-20	2	18	90° abwärts / downwards
30-471-30	3	18	90° abwärts / downwards
30-473-10	1	18	40° abwärts / downwards
30-473-20	2	18	40° abwärts / downwards
30-473-30	3	18	40° abwärts / downwards
30-477-10	1	23	40° aufwärts / upwards
30-477-20	2	23	40° aufwärts / upwards
30-477-30	3	23	40° aufwärts / upwards
30-477-40	4	23	40° aufwärts / upwards
30-477-50	5	23	40° aufwärts / upwards
30-477-60	6	23	40° aufwärts / upwards
30-478-10	1	23	90° aufwärts / upwards
30-478-20	2	23	90° aufwärts / upwards
30-478-30	3	23	90° aufwärts / upwards
30-478-40	4	23	90° aufwärts / upwards
30-478-50	5	23	90° aufwärts / upwards
30-478-60	6	23	90° aufwärts / upwards

Art.-Nr. Art.-No.	Größe Size (mm)	Länge Length (cm)	Winkel Angle
30-479-10	1	23	90° abwärts / downwards
30-479-20	2	23	90° abwärts / downwards
30-479-30	3	23	90° abwärts / downwards
30-479-40	4	23	90° abwärts / downwards
30-479-50	5	23	90° abwärts / downwards
30-479-60	6	23	90° abwärts / downwards
30-483-10	1	20	40° aufwärts / upwards
30-483-20	2	20	40° aufwärts / upwards
30-483-30	3	20	40° aufwärts / upwards
30-483-40	4	20	40° aufwärts / upwards
30-483-50	5	20	40° aufwärts / upwards
30-483-60	6	20	40° aufwärts / upwards
30-484-10	1	20	90° aufwärts / upwards
30-484-20	2	20	90° aufwärts / upwards
30-484-30	3	20	90° aufwärts / upwards
30-484-40	4	20	90° aufwärts / upwards
30-484-50	5	20	90° aufwärts / upwards
30-484-60	6	20	90° aufwärts / upwards
30-485-10	1	20	90° abwärts / downwards
30-485-20	2	20	90° abwärts / downwards
30-485-30	3	20	90° abwärts / downwards
30-485-40	4	20	90° abwärts / downwards
30-485-50	5	20	90° abwärts / downwards
30-485-60	6	20	90° abwärts / downwards
30-485-10 TAN	1	20	90° abwärts, geschwärzt downwards, black coated
30-485-40 TAN	4	20	90° abwärts, geschwärzt downwards, black coated



07 Mikroskopische/Endoskopische Instrumente für die Pansinus-Chirurgie

Microscopic/Endoscopic Instruments for Pansinus Surgery



Flexibler Spannarm zur Verwendung mit selbsthaltenden NNH-Spekula, mit Verlängerungsstange
Flexible holding arm for use with self retaining nasal specula, inclusive holding rod

30-700-00



Gelenkkloben zur Befestigung am OP-Tisch, passend für 30-700-00 und 40-337-00
Rotation clamp for fixation to operating table, for 30-700-00 and 40-337-00

30-700-01



13,5 cm

NNH-Spekulum für Kinder, linkes Blatt 25 mm, 13,5 cm
Sinus speculum for children, left blade 25 mm, 13.5 cm

30-702-25

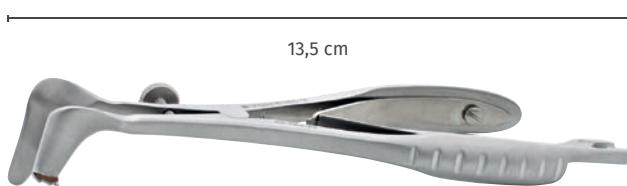

13,5 cm

NNH-Spekulum für Kinder, rechtes Blatt 25 mm, 13,5 cm
Sinus speculum for children, right blade 25 mm, 13.5 cm

30-703-25



15 cm

NNH-Spekulum für Erwachsene, 15 cm
Sinus speculum for adults, 15 cm

Art.-Nr. Art.-No.	Größe Size (mm)	Beschreibung Description
30-705-55	55	linkes Blatt / left blade
30-705-65	65	linkes Blatt / left blade
30-705-75	75	linkes Blatt / left blade
30-706-55	55	rechtes Blatt / right blade
30-706-65	65	rechtes Blatt / right blade
30-706-75	75	rechtes Blatt / right blade

07 Mikroskopische/Endoskopische Instrumente für die Pansinus-Chirurgie

Microscopic/Endoscopic Instruments for Pansinus Surgery

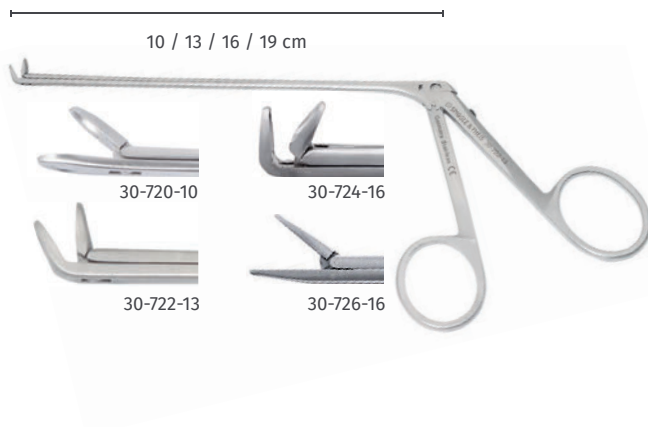

Draf Siebbeinzängchen / Draf ethmoid forceps

Art.-Nr. Art.-No.	Größe Size (mm)	Länge Length (cm)	Winkel Angle
30-720-10	4,0 x 1,8	10	gerade / straight
30-720-13	4,0 x 1,8	13	gerade / straight
30-720-16	7,0 x 2,4	16	gerade / straight
30-720-19	7,0 x 2,4	19	gerade / straight
30-722-13	6,5 x 2,4	13	60° aufgebogen / angled
30-722-16	6,5 x 2,4	16	60° aufgebogen / angled
30-722-19	6,5 x 2,4	19	60° aufgebogen / angled
30-724-13	6,0 x 2,4	13	90° aufgebogen / angled
30-724-16	6,0 x 2,4	16	90° aufgebogen / angled
30-724-19	4,0 x 1,8	19	90° aufgebogen / angled
30-726-13	3,0 x 1,5	13	gerade / straight
30-726-16	3,0 x 1,5	16	gerade / straight



Draf Siebbeinzängchen, gerade, fein gerieft

Draf ethmoid forceps, straight, finely serrated

Art.-Nr./No.	Länge / Length (cm)
30-728-16	16
30-728-19	19



Draf Siebbeinzängchen, gerade, grob gerieft, 16 cm

Draf ethmoid forceps, straight, coarsely serrated, 16 cm

30-729-16



30-732-16



30-733-16

Draf Siebbeinscherchen / Draf ethmoid scissors

Art.-Nr. Art.-No.	Länge Length (cm)	Winkel Angle
30-732-13	13	gerade / straight
30-732-16	16	gerade / straight
30-732-19	19	gerade / straight
30-733-16	16	rechts gebogen / curved right
30-734-16	16	links gebogen / curved left
30-735-19	19	45° aufwärts gebogen 45° curved upwards



07 Mikroskopische/Endoskopische Instrumente für die Pansinus-Chirurgie

Microscopic/Endoscopic Instruments for Pansinus Surgery

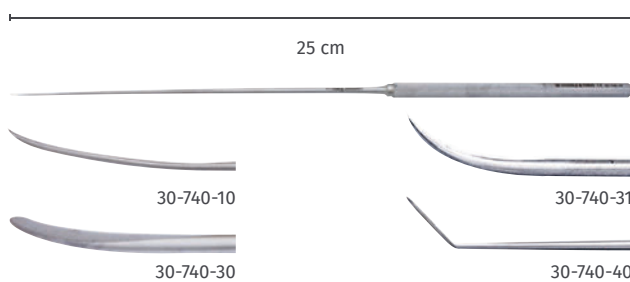

Draf Mikroraspatorium, 25 cm / Draf micro raspatory, 25 cm

Art.-Nr. Art.-No.	Größe Size (mm)	Beschreibung Description
30-740-10	1	leicht gebogen / slightly curved
30-740-30	3	leicht gebogen / slightly curved
30-740-31	3	stark gebogen / strongly curved
30-740-40	4	gewinkelt / angled

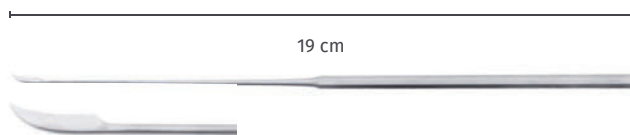

Draf Sichelmesser, 19 cm, gebogen

Draf sickle knife, 19 cm, curved

30-742-19



Draf Rundschnittmesser, 1,5 mm, 19 cm

Draf round knife, 1.5 mm, 19 cm

30-743-19



Draf Incisionsmesser, 19 cm / Draf flap knife, 19 cm

30-744-19

07 Mikroskopische/Endoskopische Instrumente für die Pansinus-Chirurgie

Microscopic/Endoscopic Instruments for Pansinus Surgery

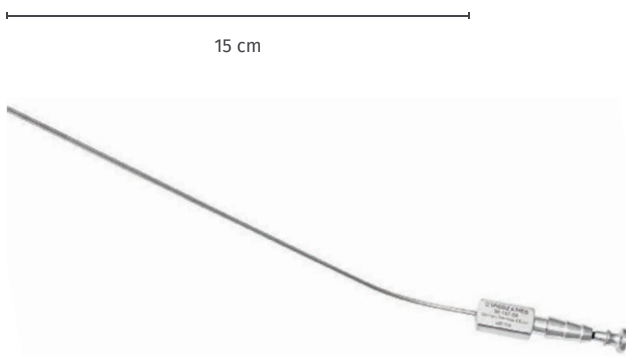

Frazier Saugrohr, 15 cm / Frazier suction tube, 15 cm

Art.-Nr./No.	Ch/Fr	mm
30-747-06	6	2,0
30-747-07	7	2,3
30-747-08	8	2,7
30-747-09	9	3,0
30-747-10	10	3,3
30-747-12	12	4,0
30-747-15	15	5,0

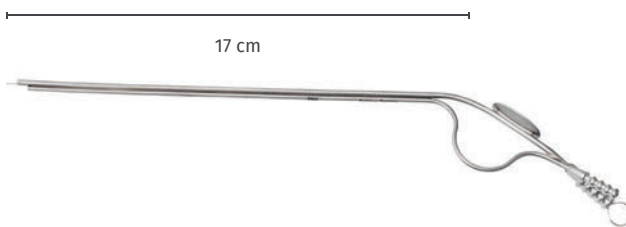

Saug- und Spülrohr, Saugrohr 2,5 mm, Spülrohr 2,0 mm, 17 cm
Suction / irrigation tube, suction tube 2.5 mm, irrigation tube 2.0 mm, 17 cm

30-749-15

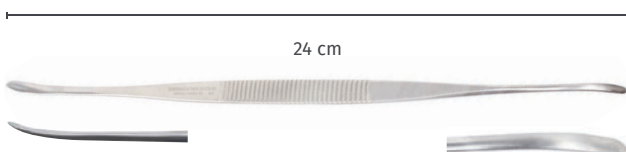

Raspa Tönnis, Größen 3 mm & 5 mm, 24 cm
Tönnis raspator, sizes 3 mm & 5 mm, 24 cm

30-759-21

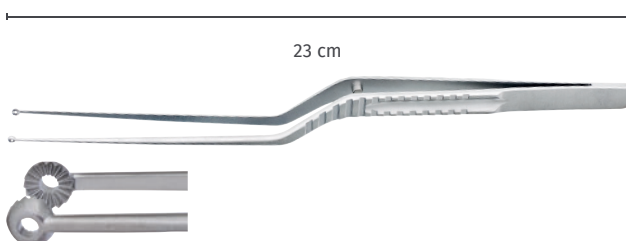

Yasargil Pinzette, ringförmig, 23 cm
Yasargil dressing forceps, ring ended, 23 cm

Art.-Nr./No.	Größe / Size (mm)
30-770-30	3
30-770-50	5



07 Mikroskopische/Endoskopische Instrumente für die Pansinus-Chirurgie

Microscopic/Endoscopic Instruments for Pansinus Surgery



Bipolare Koagulationspinzette, NON-STICK, bajonett, Führungsstift 22,5 cm
Bipolar coagulation forceps, NON-STICK, bayonet, guide pin, 22.5 cm

Art.-Nr./No.	Spitze / Tip (mm)
80-125-03	0,3
80-125-07	0,7
80-125-12	1,2

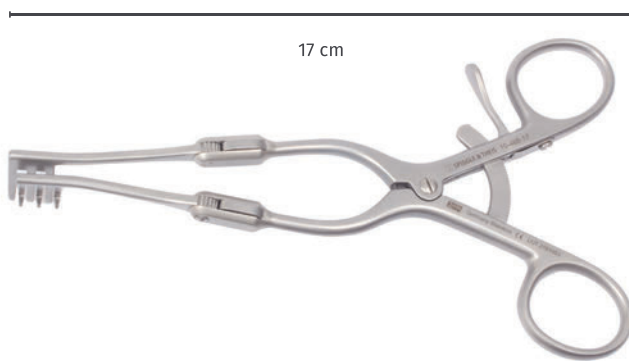

Fisch Wundsperrer mit Gelenken, 17 cm
Fisch retractor, jointed, 17 cm

Art.-Nr./No.	3:3 Zähne, halbscharf 3:3 prongs, semi-sharp
10-468-17	

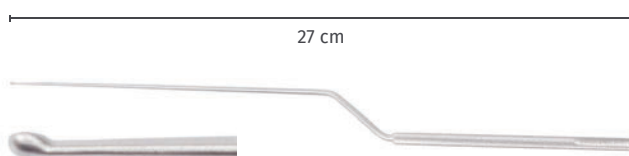

Löffelkürette, halbscharf, bajonett, gerade, nach oben, 2 mm, 27 cm
Spoon curette, semi-sharp, bayonet, straight, upwards, 2 mm, 27 cm

90-201-01

07 Mikroskopische/Endoskopische Instrumente für die Pansinus-Chirurgie

Microscopic/Endoscopic Instruments for Pansinus Surgery

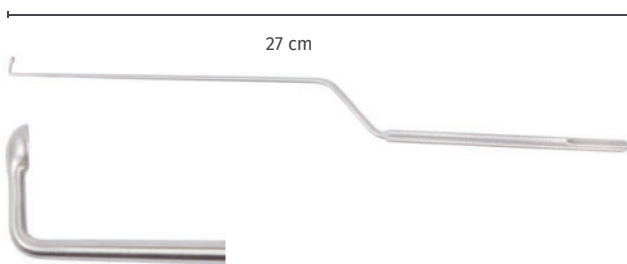

Löffelkürette, halbscharf, bajonett, 90° nach oben gebogen, mit 5 mm Steg, 27 cm

Spoon curette, semi-sharp, bayonet, 90° curved upwards, with 5 mm bar, 27 cm

Art.-Nr./No. Größe / Size (mm)

90-201-02	2
90-201-03	3

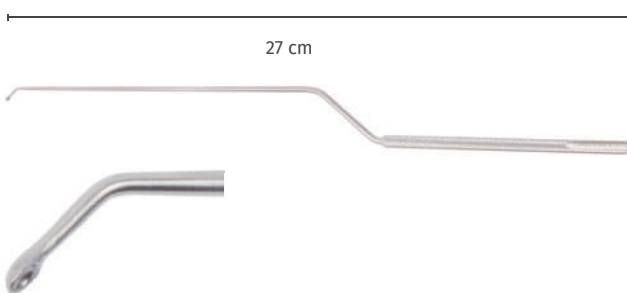

Löffelkürette, halbscharf, bajonett, mit 5 mm Steg, 27 cm

Spoon curette, semi-sharp, bayonet, with 5 mm bar, 27 cm

Art.-Nr. Größe Winkel
Art.-No. Size (mm) Angle

90-201-04	2	45° nach unten gebogen 45° curved downwards
90-201-05	2	45° nach oben gebogen 45° curved upwards
90-201-06	4	45° nach unten gebogen 45° curved downwards
90-201-07	4	45° nach oben gebogen 45° curved upwards

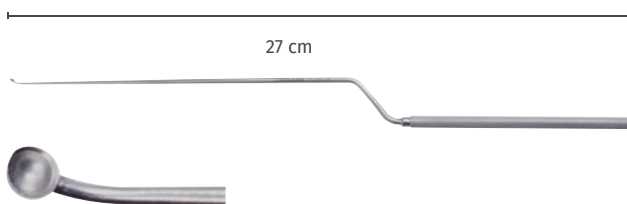

Löffelkürette, halbscharf, bajonett,

45° leicht nach oben gebogen, mit 5 mm Steg, 27 cm

Spoon curette, semi-sharp, bayonet,

45° slightly curved upwards, with 5 mm bar, 27 cm

Art.-Nr./No. Größe / Size (mm)

90-201-08	2
90-201-09	4



07 Mikroskopische/Endoskopische Instrumente für die Pansinus-Chirurgie

Microscopic/Endoscopic Instruments for Pansinus Surgery

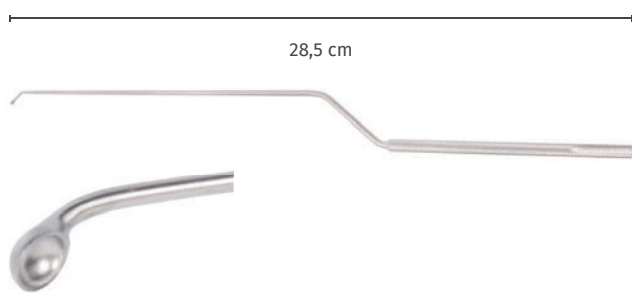

Löffelkürette, halbscharf, bajonett, mit 5 mm Steg, 28,5 cm
Spoon curette, semi-sharp, bayonet, with 5 mm bar, 28.5 cm

Art.-Nr./No.	Größe / Size (mm)	Winkel / Angle
90-201-14	2	45° nach unten gebogen 45° curved downwards
90-201-15	2	45° nach oben gebogen 45° curved upwards
90-201-16	4	45° nach unten gebogen 45° curved downwards
90-201-17	4	45° nach oben gebogen 45° curved upwards

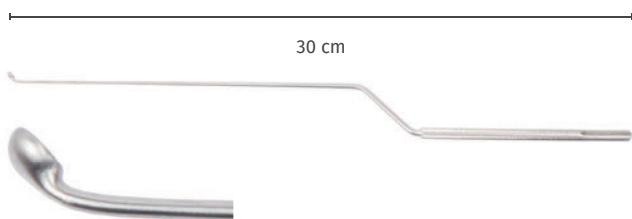

Löffelkürette, halbscharf, bajonett, 30 cm
Spoon curette, semi-sharp, bayonet, 30 cm

Art.-Nr./No.	Größe / Size (mm)	Winkel / Angle
90-201-18	2	45° leicht nach oben gebogen 45° slightly curved upwards
90-201-19	4	45° leicht nach oben gebogen 45° slightly curved upwards
90-201-28	2	45° leicht nach unten gebogen 45° slightly curved downwards
90-201-29	4	45° leicht nach unten gebogen 45° slightly curved downwards

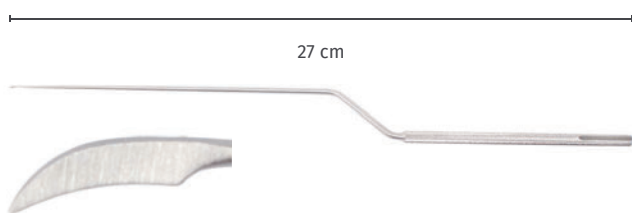

Sichelmesser spitz, bajonett, 27 cm
Sickle knife pointed, bayonet, 27 cm

Art.-Nr./No.	Beschreibung / Description
90-202-01	nach rechts gebogen / curved right
90-202-02	nach links gebogen / curved left

07 Mikroskopische/Endoskopische Instrumente für die Pansinus-Chirurgie

Microscopic/Endoscopic Instruments for Pansinus Surgery

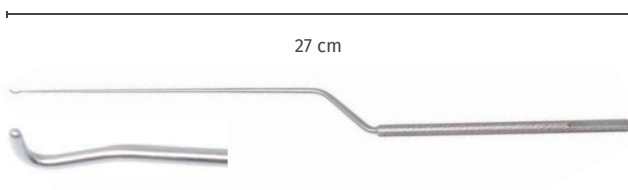

Enucleator, Rändelgriff, bajonett, 27 cm
Enucleator, knurled handle, bayonet, 27 cm

Art.-Nr./No.	Beschreibung / Description
90-204-01	nach links gebogen / curved left
90-204-02	nach rechts gebogen / curved right

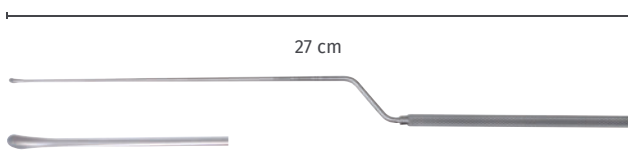

Raspatorium, scharf, bajonett, 27 cm
Raspatory, sharp, bayonet, 27 cm

Art.-Nr./No.	Beschreibung / Description
90-206-01	nach links gebogen / curved left
90-206-02	nach rechts gebogen / curved right
90-206-03	nach unten gebogen / curved downwards
90-206-04	nach oben gebogen / curved upwards

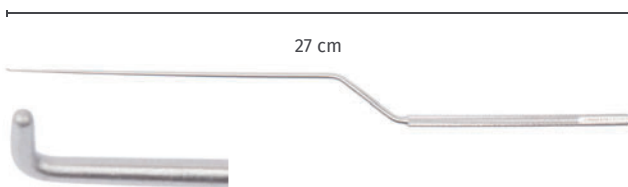

Sondenhäkchen, stumpf, bajonett, 27 cm
Probe hook, blunt, bayonet, 27 cm

Art.-Nr./No.	Beschreibung / Description
90-208-01	nach links gebogen / curved left
90-208-02	nach rechts gebogen / curved right

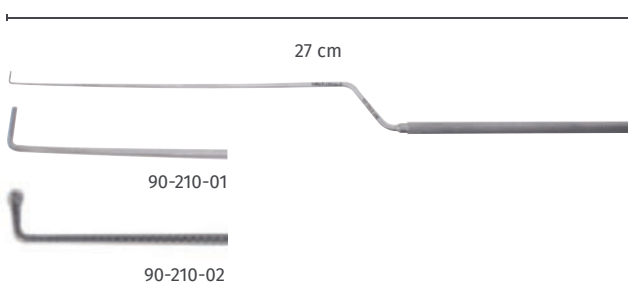

Haken, nach oben gebogen, 90°, bajonett, 27 cm
Hook, curved upwards, 90°, bayonet, 27 cm

Art.-Nr. Art.-No.	Größe Size (mm)	Beschreibung Description
90-210-01		stumpf / blunt
90-210-02	1	mit Sondenknopf / with ball end



07 Mikroskopische/Endoskopische Instrumente für die Pansinus-Chirurgie

Microscopic/Endoscopic Instruments for Pansinus Surgery

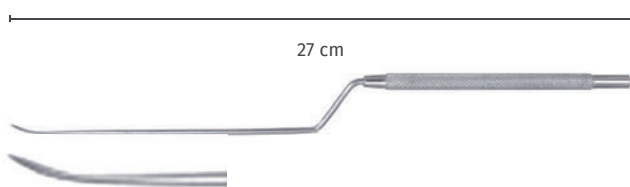

Dissektor, stumpf, nach oben gebogen, 3 mm, bajonett, 27 cm
Dissector, blunt, curved upwards, 3 mm, bayonet, 27 cm

90-210-03

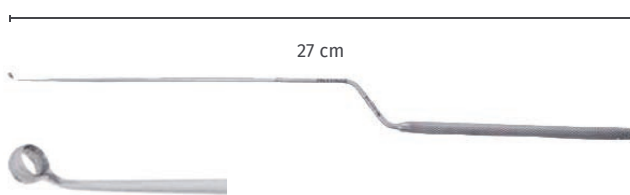

Ringkürette, scharf, nach oben gebogen, bajonett, 27 cm
Ring curette, sharp, curved upwards, bayonet, 27 cm

Art.-Nr./No.	Größe / Size (mm)	Winkel / Angle
90-210-04	2	45°
90-210-05	2	90°
90-210-06	4	45°
90-210-07	4	90°
90-210-08	5	90°

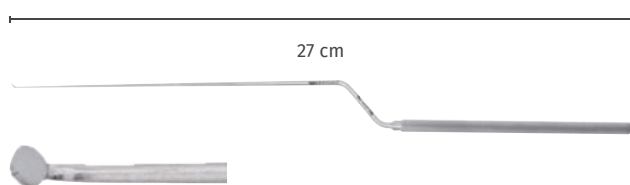

Tellermesser, nach oben gebogen, 45°, bajonett, 27 cm
Separator, curved upwards, 45°, bayonet, 27 cm

Art.-Nr./No.	Größe / Size (mm)
90-210-09	1,5
90-210-10	3,5

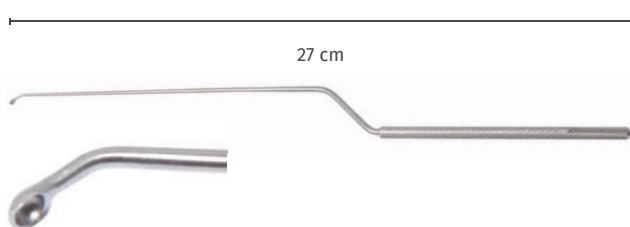

Löffelkürette, halbscharf, nach unten gebogen, 2,5 mm, 45°, bajonett, 27 cm
Spoon curette, semi-sharp, curved downwards, 2.5 mm, 45°, bayonet, 27 cm

90-211-01

07 Mikroskopische/Endoskopische Instrumente für die Pansinus-Chirurgie

Microscopic/Endoscopic Instruments for Pansinus Surgery

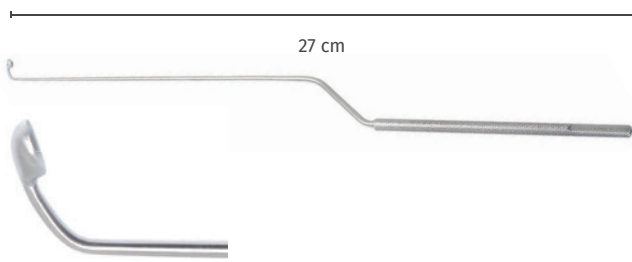

Löffelkürette, halbscharf, bajonett, 27 cm
Spoon curette, semi-sharp, bayonet, 27 cm

Art.-Nr. Art.-No.	Größe Size (mm)	Winkel Angle
90-212-01	4,5	leicht nach oben gebogen slightly curved upwards
90-212-02	4,5	stark nach oben gebogen strongly curved upwards
90-212-03	4,5	45° nach oben gebogen 45° curved upwards

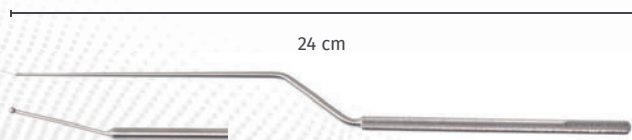

Knopfsonde, bajonett, Sonde gewinkelt, 9,5 mm, 24 cm
Ball-end probe, bayonet, probe angled, 9.5 mm, 24 cm

90-213-00

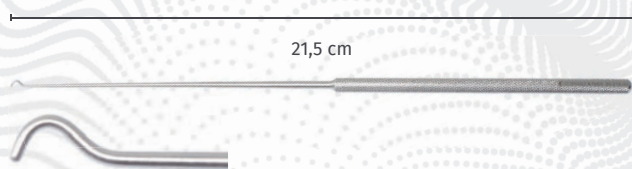

Mikro-Häkchen, vorwärts/rückwärts, stumpf, gerade, 21,5 cm
Micro hook, forward/backward, blunt, straight, 21.5 cm

90-214-00

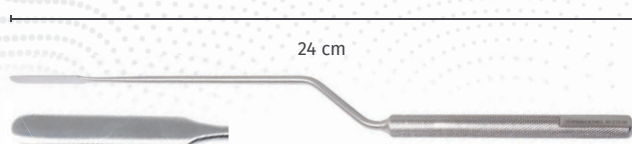

Mukosa Dissektor, bajonett, 30 x 6 mm, 24 cm
Mucosa dissector, bayonet, 30 x 6 mm, 24 cm

90-215-00



07 Mikroskopische/Endoskopische Instrumente für die Pansinus-Chirurgie

Microscopic/Endoscopic Instruments for Pansinus Surgery



Spiegel-Griff, bajonett, rund gerändelt, 15,5 cm
Mirror handle, bayonet, knurled, 15.5 cm

90-220-00

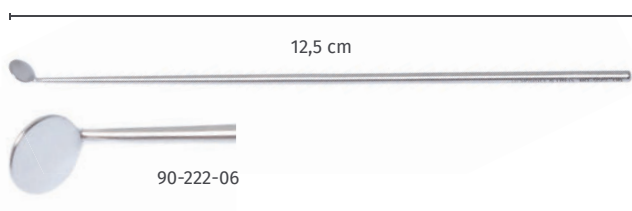

Spiegel, rund, hochglanzpoliert, extra fein, 12,5 cm,
zur Verwendung mit Handgriff 90-220-00

Mirror, round, polished, very fine, 12.5 cm,
for use with handle 90-220-00

Art.-Nr./No.	Größe / Size (mm)
90-222-04	4
90-222-05	5
90-222-06	6
90-222-08	8
90-222-10	10
90-222-12	12



Halle Kieferhöhlenkürette, doppelseitig, 21 cm
Halle antrum curette, double ended, 21 cm

30-805-00

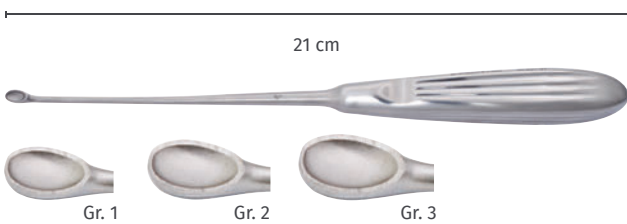

Halle Kieferhöhlenlöffel, biegsam, 21 cm
Halle antrum curette, bendable, 21 cm

Art.-Nr./No.	Größe / Size (mm)
30-807-01	1
30-807-02	2
30-807-03	3

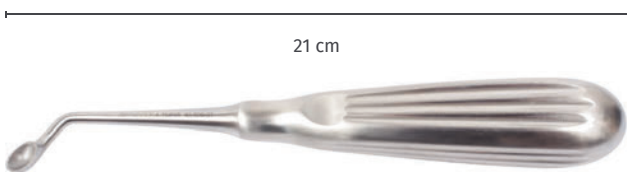

Uffenorde Kieferhöhlenlöffel, 21 cm
Uffenorde antrum curette, 21 cm

Art.-Nr./No.	Beschreibung / Description
30-809-01	links gebogen / curved left
30-809-02	rechts gebogen / curved right



Orbitaschützer, 23 cm / Orbita protector, 23 cm

30-812-24

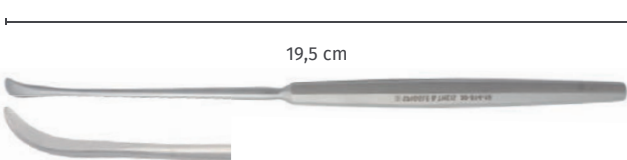

Sewall Kieferhöhlenelevatorium, 19,5 cm
Sewall antrum elevator, 19.5 cm

30-814-19



West Hohlmeißel, 4 mm, 18 cm / West gouge, 4 mm, 18 cm

30-816-40



08 Allgemeines
Miscellaneous



West Flachmeißel, 4,5 mm, 18 cm / West chisel, 4.5 mm, 18 cm
30-817-40

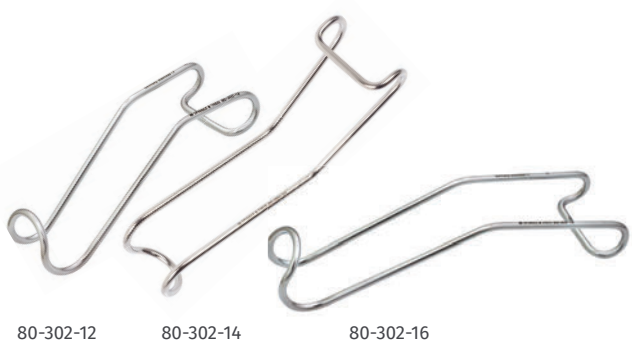

Sternberg Lippenhaken / Sternberg lip retractor

Art.-Nr./No.	Größe / Size (cm)
80-302-12	12
80-302-14	14
80-302-16	16

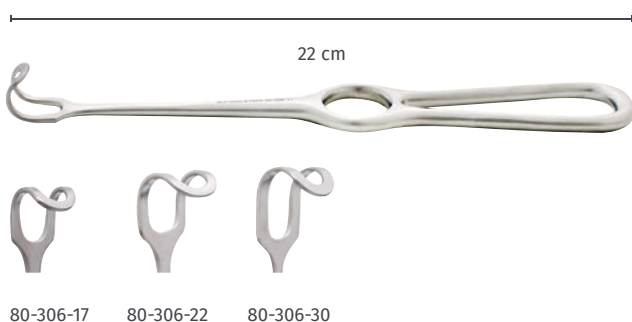

Middeldorpf Wundhaken, 22 cm / Middeldorpf retractor, 22 cm

Art.-Nr./No.	Größe / Size (mm)
80-306-17	14 x 17
80-306-22	20 x 22
80-306-30	26 x 30

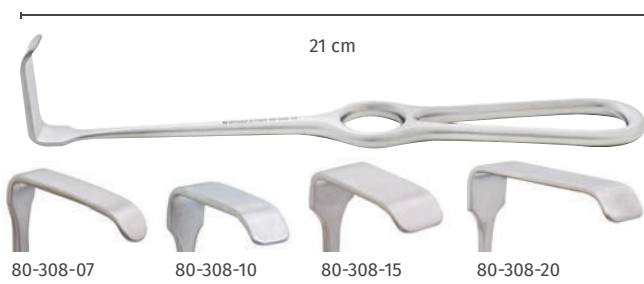

Langenbeck Wundhaken, 21 cm / Langenbeck retractor, 21 cm

Art.-Nr./No.	Größe / Size (mm)
80-308-07	35 x 7
80-308-10	35 x 10
80-308-15	35 x 15
80-308-20	60 x 20

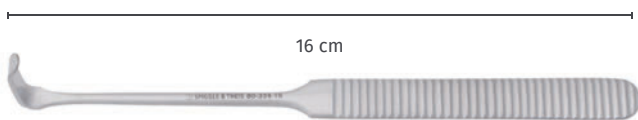

Langenbeck-Green Wundhaken, Flachgriff, 24 x 6 mm, 16 cm
Langenbeck-Green retractor, flat handle, 24 x 6 mm, 16 cm

80-334-16



Spezial Ölspray, Pflegespray für Instrumente sowie für Hand- und Winkelstücke, 500 ml
Special Oilspray, Maintenance Spray for Instruments and Drill Handpieces, 500 ml

78PS01





Metallschale / Metal bowl

Art.-Nr. Art.-No.	Durchmesser Diameter (mm)	Höhe Height (mm)	Fassungs- vermögen Capacity (ml)
80-501-01 B1	Ø 40	H=19	20
80-501-02 B2	Ø 60	H=39	60
80-501-03 B3	Ø 85	H=40	160
80-501-04 B4	Ø 110	H=55	400



Medizinbecher, Edelstahl, graduiert

Medicine cup, stainless steel, graduated

Art.-Nr. Art.-No.	Durchmesser Diameter (mm)	Höhe Height (mm)	Fassungs- vermögen Capacity (ml)
80-503-03	Ø 50	H=25	30
80-504-05	Ø 53	H=45	50



Lösungsschale, Edelstahl / Solution bowl, stainless steel

Art.-Nr. Art.-No.	Durchmesser Diameter (mm)	Höhe Height (mm)	Fassungs- vermögen Capacity (ml)
80-506-30 B1	Ø 100	H=60	300
80-507-40 B2	Ø 120	H=70	400
80-509-75 B3	Ø 150	H=75	750



Tablettenschale, Edelstahl, Ø 65 mm, H=20 mm

Tablet dish, stainless steel, Ø 65 mm, H=20 mm

80-512-00



Petrischale, Klarglas, mit Deckel / Petri dish, clear glass, with lid

Art.-Nr./No.	AD / OD (mm)	Höhe / Height (mm)
80-515-06	60	15
80-515-08	80	15
80-515-10	150	20



Medikamenten-Schälchen, Glas, schwarz, mit Deckel, 4 x 4 cm

Medication dish, glass, black, with lid, 4 x 4 cm

80-517-00

Medikamenten-Schälchen, Dappenglas, farbig, Ø 3,2 cm
Medication dish, dappen-glass, colored, Ø 3.2 cm



Art.-Nr./No.	Farbe / Color
80-519-00	kristall / crystal
80-519-01	grün / green
80-519-02	rosa / pink
80-519-03	topas / topaz

Porzellan-Schälchen, rund, mit Ausguss
China bowl, round, with spout



Art.-Nr./No.	Durchmesser / Diameter (cm)
80-520-06	Ø 8
80-520-08	Ø 10

Nierenschale, Edelstahl / Kidney bowl, stainless steel



Art.-Nr./No.	Größe / Size (cm)
80-525-17	17,5
80-525-25	25,0

Kornzangen-Behälter, Edelstahl / Forceps holder, stainless steel



Art.-Nr. Art.-No.	Durchmesser Diameter (cm)	Höhe Height (cm)
80-528-13	Ø 5,0	13,5
80-528-18	Ø 5,0	18,0
80-528-20	Ø 9,5	20,0

**Kornzangen-Behälter, Glas, Edelstahldeckel mit Ausschnitt,
 Ø 8 cm, Höhe 20 cm**

**Forceps holder, glass, stainless steel lid with opening,
 Ø 8 cm, height 20 cm**



80-530-20



09 Sterilisationssysteme

Sterilization Systems



Norm-Sterilisations-Container, Boden geschlossen
Norm sterilization container, bottom closed

Art.-Nr. Art.-No.	Größe Size	Dimension (außen) Dimension (outside) (mm)
80-631-10	1/2	297 x 274 x 88
80-631-12	1/2	297 x 274 x 123
80-631-14	1/2	297 x 274 x 138
80-631-21	1/2	297 x 274 x 188
80-641-14	3/4	462 x 274 x 138
80-661-12	1	585 x 274 x 123
80-661-14	1	585 x 274 x 138
80-661-21	1	585 x 274 x 188



Ventildeckel für Norm-Sterilisations-Container
Valve lid for norm sterilization container

Art.-Nr./No.	Art.-Nr./No.	Art.-Nr./No.
1/2 299 x 278 mm	3/4 462 x 278 mm	1 585 x 278 mm
80-632-00 ●	80-642-00 ●	80-662-00 ●
80-632-01 ●	80-642-01 ●	80-662-01 ●
80-632-02 ●	80-642-02 ●	80-662-02 ●
80-632-03 ●	80-642-03 ●	80-662-03 ●
80-632-04 ●	80-642-04 ●	80-662-04 ●
80-632-05 ●	80-642-05 ●	80-662-05 ●



Edelstahl-Siebkorb, Geflecht, Fallgriffe
Stainless-steel wire basket, sliding handles

Art.-Nr./No.	Größe / Size (mm)
80-671-20	255 x 245 x 50
80-671-25	255 x 245 x 70
80-671-40	405 x 255 x 70
80-671-60	485 x 255 x 70



Aluminium-Kennzeichnungs-Schild, 20 Zeichen, 56 x 17 mm
Coding label, 20 letters, 56 x 17 mm

Art.-Nr./No.	Farbe / Color
80-681-01	schwarz / black
80-681-02	rot / red
80-681-03	braun / brown
80-681-04	grün / green
80-681-05	gelb / yellow
80-681-06	lila / purple
80-681-07	blau / blue

Einweg-Container-Siegel, blau, 100 Stück/Box
 Container seal, disposable, blue, 100 pieces/box

80-683-10

Indikator-Klebe-Etikett, Lasche rechts, 100 Stück/Box
 Adhesive indicator label, latch right side, 100 pieces/box

80-684-10

Klemmschild aus Edelstahl, hitzebeständig,
6 x 4 cm, 25 Stück/Box
 Label holder with clip, stainless steel, heat resistant,
 6 x 4 cm, 25 pieces/box

80-688-00



Endoskopie-Siebkorb mit Deckel, Edelstahl, elektropliert
 Endoscope container with lid, stainless steel, e-polished

Art.-Nr./No.	Größe / Size (cm)
80-690-01	29 x 8 x 5,2 für 1 Endoskop 29 x 8 x 5,2 for 1 endoscope
80-690-02	29 x 8 x 5,2 für 2 Endoskope 29 x 8 x 5,2 for 2 endoscopes



Endoskopie-Siebkorb mit Deckel, Edelstahl, elektropliert
 Endoscope container with lid, stainless steel, e-polished

Art.-Nr./No.	Größe / Size (cm)
80-691-01	46 x 8 x 5,2 für 1 Endoskop 46 x 8 x 5,2 for 1 endoscope
80-692-01	67 x 8 x 5,2 für 1 Endoskop 67 x 8 x 5,2 for 1 endoscope



Sterilisations- und Aufbewahrungssystem "Instru-Safe" für NNH-Set,
270 x 245 x 152 mm

Sterilisation and protection system "Instru-Safe" for sinus surgery set,
270 x 245 x 152 mm

Vorteile / Advantages:

- Halterung für 20 Nasenzangen / Segments for 20 nasal forceps
- Leerraum für sperrige Instrumente / Space for bulky instruments
- Silikon-Noppen-Matte für feine Instrumente
Silicone finger for delicate instruments

80-611-10



10 FESS - Basis-Set 30-900-00

FESS - Basic-Set 30-900-00

Bestehend aus / Consisting of:

30-143-00	1x Sinuskop, HD, autoklavierbar, 4,0 mm, AL 175 mm, 0° 1x Sinuscope, HD, autoclavable, 4.0 mm, WL 175 mm, 0°	20-215-01	1x Blakesley Nasenzange, gerade, Gr. 1 1x Blakesley nasal forceps, straight, size 1
30-142-45	1x Sinuskop, HD, autoklavierbar, 4,0 mm, AL 175 mm, 45° 1x Sinuscope, HD, autoclavable, 4.0 mm, WL 175 mm, 45°	20-225-02	1x Blakesley Nasenzange, 45° aufgebogen, Gr. 2 1x Blakesley nasal forceps, 45° curved upwards, size 2
30-143-70	1x Sinuskop, HD, autoklavierbar, 4,0 mm, AL 175 mm, 70° 1x Sinuscope, HD, autoclavable, 4.0 mm, WL 175 mm, 70°	20-235-03	1x Blakesley Nasenzange, 90° aufgebogen, Gr. 3 1x Blakesley nasal forceps, 90° curved upwards, size 3
20-100-01	1x Hartmann Nasenspekulum für Erwachsene 1x Hartmann nasal speculum for adults	20-690-01	1x Conchotomie Schere, gerade 1x Nasal concha scissors, straight
20-150-75	1x Killian-Struycken Septumspikulum, 75 mm 1x Killian-Struycken nasal speculum, 75 mm	30-320-01	1x Durchschneidende Nasenzange, 5,0 x 1,5 mm, gerade 1x Throughcutting nasal forceps, 5.0 x 1.5 mm, straight
30-101-30	1x Eicken Spülröhrchen, kurze Biegung, Ø 3,0 mm 1x Eicken antrum cannula, short curve, Ø 3.0 mm	30-320-02	1x Durchschneidende Nasenzange, 6,0 x 2,5 mm, gerade 1x Throughcutting nasal forceps, 6.0 x 2.5 mm, straight
30-102-30	1x Eicken Spülröhrchen, kurze Biegung, Ø 3,0 mm 1x Eicken antrum cannula, short curve, Ø 3.0 mm	30-321-01	1x Durchschneidende Nasenzange, 60° gewinkelt, 5,0 x 1,5 mm 1x Throughcutting nasal forceps, 60° angled, 5.0 x 1.5 mm
30-122-08	1x Injektionskanüle, kniegebogen, 0,8 mm 1x Injection needle, angled, 0.8 mm	30-322-02	1x Durchschneidende Nasenzange, aufgebogen, 6,5 x 2,5 mm 1x Throughcutting nasal forceps, curved upwards, 6.5 x 2.5 mm
30-082-10	1x Frazier Saugrohr, Knopfende, 10 Ch/Fr 1x Frazier suction tube, ball ended, 10 Ch/Fr	30-304-25	1x Antrumstanze, rückwärts schneidend, drehbar, 2,5 mm 1x Antrum punch, backward cutting, rotatable, 2.5 mm
30-082-12	1x Frazier Saugrohr, Knopfende, 12 Ch/Fr 1x Frazier suction tube, ball ended, 12 Ch/Fr	30-468-20	1x Kerrison Keilbeinstanze, zerlegbar, 2 mm, 90° aufwärts 1x Kerrison sphenoid punch, detachable, 2 mm, 90° upwards
30-082-15	1x Frazier Saugrohr, Knopfende, 15 Ch/Fr 1x Frazier suction tube, ball ended, 15 Ch/Fr	30-333-02	1x Herberhold cranial durchschneidende Zange, 60° aufgebogen, flach, 11,5 x 2,5 mm 1x Herberhold cranial throughcutting forceps, 60° curved upwards, flat, 11.5 x 2.5 mm
20-305-18	1x Freer Doppellevatorium, scharf/stumpf 1x Freer elevator, double ended, sharp/blunt	30-308-01	1x Antrumstanze, links schneidend 1x Antrum punch, left cutting
30-155-50	1x Antrum Trokar, schnabelförmig, 5 mm AD 1x Antrum trocar, beaked, 5 mm OD	30-308-02	1x Antrumstanze, rechts schneidend 1x Antrum punch, right cutting
30-200-01	1x Sichelmesser, gerader Schaft, spitz 1x Sickle knife, straight shaft, pointed	30-422-45	1x Rundkopfstanze für Keilbeinhöhle, 0°, 4,5 mm, mit Spülkanal 1x Sphenoid sinus circular punch, 0°, 4.5 mm, with irrigation channel
30-205-02	1x Antrum-Löffel, längsoval, klein, 2,5 x 6,0 mm, 45° 1x Antrum curette, oval, small, 2.5 x 6.0 mm, 45°	30-425-45	1x Stirnhöhlen-Stanze, aufgebogen, stumpfes Ende, mit Spülkanal, 4,5 mm 1x Frontal sinus punch, curved upwards, blunt end, with irrigation channel, 4.5 mm
30-205-06	1x Stirnhöhlen-Löffel, gerader Schaft, längsoval, 90° aufgebogen 1x Frontal sinus curette, straight shaft, oval, 90° upcurved		
30-203-01	1x Antrum-Kürette, gerader Schaft, vorwärts schneidend 1x Antrum curette, straight shaft, forward cutting		
30-203-02	1x Antrum-Kürette, gerader Schaft, rückw. schneidend 1x Antrum curette, straight shaft, backward cutting		
30-410-01	1x Stirnhöhlen Biopsiezange, 70°, 3 mm, vertikal, mit Spülkanal 1x Frontal sinus biopsy forceps, 70°, 3 mm, vertical, with irrigation channel		
30-411-01	1x Stirnhöhlen Biopsiezange, 110°, 3 mm, vertikal, mit Spülkanal 1x Frontal sinus biopsy forceps, 110°, 3 mm, vertical, with irrigation channel		
30-311-02	1x Kieferhöhlen Polypen-Fasszange, rückwärts öffnend, drehbar 1x Antrum polyp grasping forceps, retrograde opening, rotatable		
30-207-01	1x Stirnhöhlen-Sonde, doppelseitig, leicht gebogen, 19 cm 1x Frontal sinus seeker, double ended, slightly curved, 19 cm		
30-207-02	1x Kieferhöhlensonde, doppelseitig, 19 cm 1x Maxillary sinus seeker, double ended, 19 cm		
30-207-03	1x Stirnhöhlensonde, doppelseitig, stark gebogen, 19 cm 1x Frontal sinus seeker, double ended, strongly curved, 19 cm		
30-402-02	1x Stirnhöhlensonde, durchschneidend, 90°, 2 mm, horizontal 1x Frontal sinus forceps, throughcutting, 90°, 2 mm, horizontal		

Ergänzung 30-900-99

Supplement 30-900-99

30-160-02	1x Ultra-Stop Antibeschlagmittel, 30 ml, Durchstichflasche, steril 1x Ultra-Stop antifog solution, 30 ml, pierce bottle, sterile
80-661-14	1x Norm-Sterilisations-Container, Boden geschlossen, 585 x 274 x 138 mm 1x Norm sterilization container, bottom closed, 585 x 274 x 138 mm
80-662-00	1x Ventildeckel, silber, für Container 80-661-14, 585 x 278 mm 1x Valve lid, silver, for container 80-661-14, 585 x 278 mm
80-671-60	1x Edelstahl-Siebkorb, Geflecht, Fallgriffe, 485 x 255 x 70 mm 1x Stainless steel wire basket, sliding handles, 485 x 255 x 70 mm
80-681-01	1x Aluminium-Kennzeichnungs-Schild, schwarz, 20 Zeichen 1x Aluminium tag, black, 20 letter

Supplement for sales in EU (outside the EU only on request)

Bestehend aus / Consisting of:

- 20-100-02 1x Hartmann Nasenspekulum für Jugendliche
1x Hartmann nasal speculum for juveniles
- 30-101-25 1x Eicken Spülröhrchen, lange Biegung, 2,5 mm Durchmesser
1x Eicken antrum cannula, long curve, 2.5 mm diameter
- 30-102-25 1x Eicken Spülröhrchen, kurze Biegung, 2,5 mm Durchmesser
1x Eicken antrum cannula, short curve, 2.5 mm diameter
- 30-082-10 1x Frazier Saugrohr, Knopfende, 10 Ch (3,3 mm)
1x Frazier suction tube, ball ended, 10 Fr (3.3 mm)
- 30-130-00 1x Sinusskop, 187,5 mm AL, 2,7 mm AD, 0°
1x Sinusscope, 187.5 mm length, 2.7 mm OD, 0°
- 30-130-30 1x Sinusskop, 187,5 mm AL, 2,7 mm AD, 30°
1x Sinusscope, 187.5 mm length, 2.7 mm outer diameter, 30°
- 30-742-19 1x Draf Sichelmesser, 19 cm, gebogen
1x Draf sickle knife, 19 cm, curved
- 20-305-18 1x Freer Doppelevatorium, scharf/stumpf
1x Freer elevator, double ended, sharp/blunt
- 30-207-01 1x Stirnhöhlen-Sonde, doppelseitig, leicht gebogen
1x Frontal sinus seeker, double ended, slightly curved
- 30-207-02 1x Kieferhöhlen-Sonde, doppelseitig
1x Maxillary sinus seeker, double end
- 30-205-02 1x Antrum-Löffel, längsoval, klein, 2,5 x 6,0 mm, 45° gewinkelt
1x Antrum curette, oval, small, 2.5 x 6.0 mm, 45° angled
- 30-205-06 1x Antrum-Löffel, längsoval, klein, 2,5 x 6,0 mm, 90° gewinkelt
1x Antrum curette, oval, small, 2.5 x 6.0 mm, 90° angled
- 30-122-08 1x Injektionskanüle, kniegebogen, 0,8 mm
1x Injection needle, angled, 0.8 mm
- 20-215-00 1x Blakesley Nasenzange, gerade, Gr. 0
1x Blakesley nasal forceps, straight, size 0
- 20-225-00 1x Blakesley Nasenzange, 45° aufgebogen, Gr. 0
1x Blakesley nasal forceps, 45° upcurved, size 0
- 30-304-15 1x Antrumstanze, rückwärts schneidend, drehbar, 1,5 mm
1x Antrum punch, backward cutting, rotatable, 1.5 mm
- 30-330-01 1x Wigand durchschneidende Zange, flach, abgerundet,
4,0 x 3,0 mm, gerade, 14 cm
1x Wigand throughcutting forceps, flat, rounded, 4.0 x 3.0 mm,
straight, 14 cm
- 30-330-02 1x Wigand durchschneidende Zange, flach, abgerundet,
4,0 x 3,0 mm, 5° aufgewinkelt, 14 cm
1x Wigand throughcutting forceps, flat, rounded, 4.0 x 3.0 mm,
45° angled, 14 cm
- 30-407-02 1x Stirnhöhlen Löffelzange, 90°, 2 mm, horizontal, mit Spülkanal
1x Frontal sinus forceps, oval cups, 90°, 2 mm, horizontal,
with irrigation channel
- 30-720-16 1x Draf Siebbeinzängchen, gerade, 4 x 1,8 mm, 16 cm
1x Draf ethmoid forceps, straight, 4 x 1.8 mm, 16 cm

Ergänzung 30-905-99

Supplement 30-905-99

- 30-160-02 1x Ultra-Stop Antibeschlagmittel, 30 ml, Durchstichflasche steril
1x Ultra-Stop antifog solution, 30 ml, pierce bottle, sterile
- 80-661-14 1x Norm-Sterilisations-Container, Boden geschlossen, 585 x 274 x 138 mm
1x Norm sterilization container, bottom closed, 585 x 274 x 138 mm
- 80-662-00 1x Ventildeckel, silber, für Container 80-661-14, 585 x 278 mm
1x Valve lid, silver, for container 80-661-14, 585 x 278 mm
- 80-671-60 1x Edelstahl-Siebkorb, Geflecht, Fallgriffe, 485 x 255 x 70 mm
1x Stainless steel wire basket, sliding handles, 485 x 255 x 70 mm
- 80-681-04 1x Aluminium-Kennzeichnungs-Schild, grün, 20 Zeichen
1x Aluminium tag, green, 20 letter

Supplement for sales in EU (outside the EU only on request)



10 Schädelbasis-Set 30-902-00

Skull base-Set 30-902-00

Bestehend aus / Consisting of:

77HW002	1x Bohrhandstück, gewinkelt, autoklavierbar, 1:1 1x Drill handpiece, angled, autoclavable, 1:1	30-732-16	1x Draf Siebbeinscherchen, gerade, 16 cm 1x Draf ethmoid scissors, straight, 16 cm
BS23509516	1x Bohrerständer für 16 rotierende Instrumente der L= 95 mm 1x Stand for 16 rotary instruments of length 95 mm	30-740-10	1x Draf Mikroraspatorium, 25 cm, 1 mm, leicht gebogen 1x Draf micro raspatory, 25 cm, 1 mm, angled
CR095011206	1x Osteotomie-Bohrer, HM, 95 mm, 1,2 mm, 6 Schneiden 1x Osteotomy bur, TC, 95 mm, 1.2 mm, 6 blades	30-740-30	1x Draf Mikroraspatorium, 25 cm, 3 mm, leicht gebogen 1x Draf micro raspatory, 25 cm, 3 mm, slightly curved
CR095011806	1x Osteotomie-Bohrer, HM, 95 mm, 1,8 mm, 6 Schneiden 1x Osteotomy bur, TC, 95 mm, 1.8 mm, 6 blades	30-740-31	1x Draf Mikroraspatorium, 25 cm, 3 mm, stark gebogen 1x Draf micro raspatory, 25 cm, 3 mm, strongly curved
CR095012306	1x Osteotomie-Bohrer, HM, 95 mm, 2,3 mm, 6 Schneiden 1x Osteotomy bur, TC, 95 mm, 2.3 mm, 6 blades	30-740-40	1x Draf Mikroraspatorium, 25 cm, 4 mm, gewinkelt 1x Draf micro raspatory, 25 cm, 4 mm, angled
CR095014008	1x Osteotomie-Bohrer, HM, 95 mm, 4,0 mm, 8 Schneiden 1x Osteotomy bur, TC, 95 mm, 4.0 mm, 8 blades	30-742-19	1x Draf Sichelmesser, 19 cm, gebogen 1x Draf sickle knife, 19 cm, curved
CR095016014	1x Osteotomie-Bohrer, HM, 95 mm, 6,0 mm, 14 Schneiden 1x Osteotomy bur, TC, 95 mm, 6.0 mm, 14 blades	30-743-19	1x Draf Rundschnittmesser, 19 cm, 1,5 mm 1x Draf round knife, 19 cm, 1.5 mm
DR095011891	1x Diamantbohrer, 95 mm, 1,8 mm mittel 1x Diamond bur, 95 mm, 1.8 mm, medium	30-744-19	1x Draf Incisionsmesser, 19 cm 1x Draf incision knife, 19 cm
DR095012791	1x Diamantbohrer, 95 mm, 2,7 mm mittel 1x Diamond bur, 95 mm, 2.7 mm, medium	30-747-06	1x Frazier Saugrohr, 15 cm, 6 Ch/Fr (2,0 mm) 1x Frazier suction tube, 15 cm, 6 Ch/Fr (2.0 mm)
DR095013591	1x Diamantbohrer, 95 mm, 3,5 mm mittel 1x Diamond bur, 95 mm, 3.5 mm, medium	30-747-08	1x Frazier Saugrohr, 15 cm, 8 Ch/Fr (2,7 mm) 1x Frazier suction tube, 15 cm, 8 Ch/Fr (2.7 mm)
DR095014591	1x Diamantbohrer, 95 mm, 4,5 mm mittel 1x Diamond bur, 95 mm, 4.5 mm, medium	30-748-10	1x Frazier Saugrohr, 15 cm, 10 Ch/Fr (3,3 mm) 1x Frazier suction tube, 15 cm, 10 Ch/Fr (3.3 mm)
DR095016091	1x Diamantbohrer, 95 mm, 6,0 mm mittel 1x Diamond bur, 95 mm, 6.0 mm, medium	30-749-15	1x Saug- und Spülrohr, 17 cm, 2,5 / 2,0 mm 1x Suction/irrigation tube, 17 cm, 2.5 / 2.0 mm
DR095013593	1x Diamantbohrer, 95 mm, 3,5 mm, grob 1x Diamond bur, 95 mm, 3.5 mm, coarse	30-770-30	1x Yasargil Pinzette, ringförmig, 22 cm 1x Yasargil dressing forceps, ring ended, 22 cm
DR095016093	1x Diamantbohrer, 95 mm, 6,0 mm, grob 1x Diamond bur, 95 mm, 6.0 mm, coarse	30-759-21	1x Tönnis Gefäßraspatorium, 21,5 cm 1x Tönnis raspatory, 21.5 cm
30-700-00	1x Flexibler Spannarm für Spekula, mit Verlängerung 1x Flexible holding arm for specula, incl. holding rods	80-125-07	1x Bipolare Koagulationspinzette, NON-STICK, bajonett, Führungsstift 22,5 cm, 0,7 mm 1x Bipolar coagulation forceps, NON-STICK, bayonet, guide pin, 22.5 cm, 0.7 mm
30-700-01	1x Gelenkkloben zur Befestigung am OP-Tisch 1x Rotation clamp for fixation to operating table	80-318-50	1x Bipolares Anschlusskabel passend für Erbe/Storz, 5 m 1x Bipolar cable, for Erbe/Storz, 5 m
30-705-55	1x NNH-Spekulum für Erw., 13,5 cm, 55 mm linkes Blatt 1x Sinus speculum f. adults, 13.5 cm, 55 mm left blade		
30-705-75	1x NNH-Spekulum f. Erw., 13,5 cm, 75 mm linkes Blatt 1x Sinus speculum f. adults, 13.5 cm, 75 mm left blade		
30-706-55	1x NNH-Spekulum f. Erw., 13,5 cm, 55 mm rechtes Blatt 1x Sinus speculum f. adults, 13.5 cm, 55 mm right blade		
30-706-75	1x NNH-Spekulum f. Erw., 13,5 cm, 75 mm rechtes Blatt 1x Sinus speculum f. adults, 13.5 cm, 75 mm right blade		
30-720-16	1x Draf Siebbeinzängchen, 4 x 1,8 mm, 16 cm, gerade 1x Draf ethmoid forceps, 4 x 1.8 mm, 16 cm, straight	80-661-14	1x Norm-Sterilisations-Container, Boden geschlossen, 585 x 274 x 138 mm 1x Norm sterilization container, bottom closed, 585 x 274 x 138 mm
30-722-16	1x Draf Siebbeinzängchen, 4 x 1,8 mm, 16 cm, 45° aufgebogen 1x Draf ethmoid forceps, 4 x 1.8 mm, 16 cm, 45° angled	80-662-00	1x Ventildeckel, silber, für Container 80-661-14, 585 x 278 mm 1x Valve lid, silver, for container 80-661-14, 585 x 278 mm
30-724-16	1x Draf Siebbeinzängchen, 4 x 1,8 mm, 16 cm, 90° aufgebogen 1x Draf ethmoid forceps, 4 x 1.8 mm, 16 cm, 90° angled	80-671-60	1x Edelstahl-Siebkorb, Geflecht, Fallgriffe, 485 x 255 x 70 mm 1x Stainless steel wire basket, sliding handles, 485 x 255 x 70 mm
30-726-16	1x Draf Siebbeinzängchen, 3 x 1,5 mm, 16 cm, gerade 1x Draf ethmoid forceps, 3 x 1.5 mm, 16 cm, straight	80-681-06	1x Aluminium-Kennzeichnungs-Schild, lila, 20 Zeichen 1x Aluminium tag, purple, 20 letter
30-728-16	1x Draf Siebbeinzängchen, fein gerieft, 16 cm, gerade 1x Draf ethmoid forceps, fine serrated, 16 cm, straight		

Ergänzung 30-902-99

Supplement 30-902-99

80-661-14	1x Norm-Sterilisations-Container, Boden geschlossen, 585 x 274 x 138 mm 1x Norm sterilization container, bottom closed, 585 x 274 x 138 mm
80-662-00	1x Ventildeckel, silber, für Container 80-661-14, 585 x 278 mm 1x Valve lid, silver, for container 80-661-14, 585 x 278 mm
80-671-60	1x Edelstahl-Siebkorb, Geflecht, Fallgriffe, 485 x 255 x 70 mm 1x Stainless steel wire basket, sliding handles, 485 x 255 x 70 mm
80-681-06	1x Aluminium-Kennzeichnungs-Schild, lila, 20 Zeichen 1x Aluminium tag, purple, 20 letter

Supplement for sales in EU (outside the EU only on request)

Adson-Brown Pinzette.....	20	Injektionskanüle	8	Stirnhöhle-sonde.....	29
Antifog.....	13	Jansen Nasenpinzette.....	20	Stirnhöhle-stande	43
Antrum-Kürette	27	Joseph Schere	19	Stirnhöhle-zange.....	44
Antrum-Löffel.....	27	Kerrison Keilbeinstanze.....	49	Strümpel-Voss Nasenzange	25
Antrum-Trokar.....	12	Kieferhöhlen Polypen-Fasszange	32	Spiegel	60
Antrumstanze, rückwärts schneidend	30-31	Kieferhöhlen-sonde.....	29	Spiegel-Handgriff.....	60
Antrumstanze, seitwärts schneidend.....	31	Kieferhöhlen-Spülschlauch.....	7	Tablettenschale	64
Beyer Knochenstanze für Kinder	47	Killian-Struycken Septumspekulum.....	19	Takahashi Nasenzange	26, 35
Binner Polypenfasszange.....	44	Kornzangenbehälter.....	65	Tellermesser	58
Biopsiezange	8, 45	Knochenstanze mit Reservoir.....	46	Tobey Mikro-Antrumstanze.....	31
Bipolare Koagulationspinzette.....	54	Krause Nasenpolypenschnürer.....	22	Tönnis Gefäßraspatorium	53
Bipolare Pinzette.....	23	Langenbeck Wundhaken.....	63	Uffenorde Kieferhöhlenlöffel	61
Bipolares Anschlusskabel.....	23, 54	Langenbeck-Green Wundhaken.....	63	Ultra-Stop Antibeschlagmittel.....	12
Blakesley Nasenzange	24-26, 35-37	LED-Leuchtgriff.....	14	Walter Schere.....	19
Codierschild.....	66	Lichtleitkabel	17	Watteträger	20
Conchotomie Schere	28-29	Lichtwitz Punktionskanüle	7	Weber Doppelevatorium	21
Container-Siegel.....	67	Löffelkürette.....	54-59	Weber Nasenschere	28
Cottle Columella-Klemme.....	20	Löffelzange.....	33	West Flachmeißel.....	62
Cottle Hammer.....	22	Lösungsschale.....	64	West Hohlmeißel.....	61
Cottle Meißel.....	22	Mandrin.....	46	Wigand durchschneidende Zange.....	34
Cottle Nasenflügelhaken.....	23	Masing Elevatorium/Raspatorium	21	Wigand Polypen-Fasszange	25
Cottle Septum-Messer.....	20	Masing Ritzmesser.....	21	Wigand Stirnhöhle-raspel.....	28
Crile-Wood Nadelhalter	22	Matrix LED 100 duo.....	17	Yasargil Pinzette	53
Desinfektions Wandhalterung für Endoskope.....	18	McKenty Keilbeinstanze	48		
Desinfektions-System für Endoskope.....	18, 65	Medikamentenschälchen.....	64-65		
Dichtigkeitstester für flexible Endoskope	16	Medizinbecher	64		
Dissektor.....	58	Metallschale	63		
Dieler bipolare Koagulationszangen	39-42	Middeldorf Wundhaken.....	62		
Draf Incisionsmesser	52	Mikro-Häkchen	59		
Draf Mikroraspatorium	52	Mukosa Dissektor.....	59		
Draf Rundschnittmesser	52	Nasenpolypenschlingen.....	22		
Draf Sichelmesser.....	52	Nasensonde S-förmig.....	23		
Draf Siebbeinscherchen.....	51	Nierenschale.....	65		
Draf Siebbeinzängchen.....	51	NNH-Spekulum	50		
Durchschneidende Nasenzange	33	Norm-Sterilisationscontainer.....	66		
Durchschneidende Saugzange.....	34	Ölspray für Instrumente.....	63		
Eicken Spülröhrchen.....	5	Orbitaschützer	61		
Endoskope	9-11	Pädiatisches FESS-SET.....	69		
Endoskop-Schutzhülse.....	13	Petrischale	64		
Enucleator	57	Porzellanschälchen	65		
FESS-Basis-Set.....	68	Raspatorium	57		
Fiberglas-Lichtleitkabel.....	17	Reynolds Schere.....	19		
Fisch Wundsperrerr.....	54	Ritter Stirnhöhle-bougie.....	8		
Flexible Alligatorzange	16	Ringkürette	58		
Flexible Löffelzange.....	16	Rundkopfstanze für Keilbeinhöhle	45, 46		
Flexibler Spannarm	50	Rundkopfstanze für Stirnhöhle	43		
Flexibles Endoskop.....	15, 16	Saug- und Spülhandgriff.....	13		
Frazier Saugrohr	6, 53	Saug- und Spülrohr	53		
Freer Doppelevatorium.....	21	Saug- und Spülschaft	13		
Gelenkkloben	50	Schädelbasis-Set.....	70		
Grünwald Rohrschaftzange	38	Schwager Stanze	47		
Guillen Saugraspatorium	21	Sewall Kieferhöhlen-elevatorium	61		
Haken	57	Sichelmesser.....	27, 56		
Handgriff für Endoskope.....	12	Siebkorb	66		
Hammer	22	Sinuskop	9-11		
Hajek-Kofler Keilbeinstanze	43-44	Sondenhäkchen.....	57		
Halle Kieferhöhlenkürette.....	61	Sterilisations-System "InstruSafe"	67		
Halle Kieferhöhlenlöffel.....	61	Sternberg Lippenhaken.....	62		
Hartmann Nasenspekulum	5	Stirnhöhle-Biopsiezange	45		
Hartmann Nasentamponadezange	25	Stirnhöhle-Löffel.....	28		
Herberhold cranial durchschneidende Zange.....	34	Stirnhöhle-löffelzange.....	45		
Hochleistungs-Fiberglas-Lichtleitkabel.....	17	Stirnhöhle-saugraspatorium	7		
Indikator-Klebeetikett.....	67	Stirnhöhle-saugrohr.....	7		



Alphabetical Index

Adhesive indicator label.....	67	Halle antrum curette.....	61	Suction- and irrigation handle	13
Adson-Brown forceps	20	Hartmann nasal dressing forceps	25	Suction- and irrigation sheath.....	13
Antifog.....	13	Hartmann nasal speculum	5	Tablet dish	64
Antrum curette.....	27	Herberhold cranial throughcutting forceps	34	Takahashi nasal forceps.....	26
Antrum polyp grasping forceps.....	32	High definition fibre light cable	17	Takahashi suction forceps.....	35
Antrum punch with collector.....	46	Hook.....	57	Tobey micro antrum punch.....	31
Antrum punch	30-31, 46	Injection needle	8	Tönnis raspatory.....	53
Antrum trocar.....	12	Jansen nasal forceps.....	20	Throughcutting nasal forceps.....	33
Basket.....	66	Joseph scissors.....	19	Throughcutting suction forceps.....	34
Beyer antrum punch.....	45	Kerrison sphenoid punch	49	Uffendorde antrum curette	61
Binner polyp forceps.....	44	Kidney bowl.....	65	Ultra-Stop anti-fog solution	12
Biopsy forceps	8	Killian-Struycken septum speculum	19	Valve lid for norm sterilization container.....	66
Bipolar cable.....	23, 54	Krause nasal polyp snare	22	Walter scissors.....	19
Bipolar coagulation forceps.....	54	Langenbeck-Green retractor.....	63	Weber elevator	21
Bipolar forceps	23	Langenbeck retractor.....	63	Weber nasal scissors.....	28
Blakesley nasal forceps.....	24-26, 35-37	Leak tester for flexible endoscopes	16	West chisel.....	62
China bowl.....	65	LED light handles	14	West gouge.....	61
Clip on coding clamp	67	Lichtwitz trocar needle.....	7	Wigand frontal sinus rasp.....	28
Coding labels.....	66	Mallet.....	22	Wigand polyp grasping forceps.....	25
Container seal.....	67	Masing elevator/raspatory	21	Wigand throughcutting forceps	34
Cottle alar retractor.....	23	Masing pointed knife	21	Yasargil dressing forceps	53
Cottle chisel.....	22	Matrix LED 100 duo.....	17		
Cottle columella forceps.....	20	Maxillary sinus seeker.....	29		
Cottle mallet.....	22	McKenty sphenoid punch.....	48		
Cottle septum knife.....	20	Medicine cup.....	64		
Cotton carrier.....	20	Medication dish.....	64-65		
Crile-Wood needleholder	22	Metal bowl	63		
Cup forceps.....	33	Micro hook	59		
Dissector.....	58	Middeldorpf antrum retractor.....	62		
Dieler bipolar Coagulation forceps.....	39-42	Mirror.....	60		
Disinfection wall holder for endoscopes.....	18	Mirror handle	60		
Draf ethmoid forceps.....	51	Mucosa dissector.....	59		
Draf ethmoid scissors.....	51	Nasal conchotomy scissors.....	28, 29		
Draf flap knife	52	Nasal polyp snare wires	22		
Draf micro raspatory.....	52	Nasal probe	23		
Draf round knife	52	Norm sterilization container	66		
Draf sickle knife.....	52	Oil spray for instruments.....	63		
Eicken antrum cannula.....	5	Orbita protector	61		
Endoscope.....	9-11	Pediatric FESS-Set.....	69		
Endoscope container with lid.....	67	Petri dish	64		
Endoscope handle	12	Probe hook.....	57		
Endoscope protection sleeve	13	Raspatory.....	57		
Endoscope sterilizing/protecting tray	13, 66	Reynolds scissors.....	19		
Enucleator	57	Ring curette	58		
FESS-Basic-Set.....	68	Ritter frontal sinus bougie.....	8		
Fibre light cable.....	17	Rotation clamp for fixation to operating table	50		
Fisch Retractor.....	54	Schwager punch	47		
Flexible alligator forceps	16	Seperator.....	58		
Flexible endoscope.....	15, 16	Sewall antrum elevator	61		
Flexible holding arm.....	60	Sickle knife.....	27, 56		
Forceps holder.....	65	Sinus irrigation tube	7		
Frazier suction tube.....	6, 53	Sinus speculum for adults	50		
Freer double elevator	21	Sinus speculum for children.....	50		
Frontal sinus biopsy forceps.....	45	Sinus suction tube.....	7		
Frontal sinus circular punch	43	Sinuscope.....	9-11		
Frontal sinus curette.....	28	Solution bowl.....	64		
Frontal sinus forceps.....	44	Skull base Set.....	70		
Frontal sinus punch.....	43	Sphenoid sinus circular punch	45, 46		
Frontal sinus probe	29	Spoon curette.....	54-59		
Frontal sinus suction raspatory	7	Sterilizing system "Instru Safe"	67		
Frontal sinus suction tube.....	7	Sternberg lip retractor.....	62		
Grünwald tubular forceps.....	38	Strümpel-Voss nasal forceps.....	25		
Guillen suction raspatory	21	Stylet	46		
Hajek-Kofler sphenoid punch	47, 48	Suction/Irrigation tube.....	53		

Numerisches Inhaltsverzeichnis

Numeric Content

30-469-40.....	49	30-720-13.....	51	70-266-02.....	17	80-525-25.....	65	90-201-15.....	56
30-469-50.....	49	30-720-16.....	51	70-470-00.....	18	80-528-13.....	65	90-201-16.....	56
30-471-10.....	49	30-720-19.....	51	70-472-00.....	18	80-528-18.....	65	90-201-17.....	56
30-471-20.....	49	30-722-13.....	51	80-090-00.....	40	80-528-20.....	65	90-201-18.....	56
30-471-30.....	49	30-722-16.....	51	80-090-01.....	40	80-530-20.....	65	90-201-19.....	56
30-473-10.....	49	30-722-19.....	51	80-090-02.....	42	80-611-10.....	67	90-201-28.....	56
30-473-20.....	49	30-724-13.....	51	80-090-03.....	41	80-621-05.....	11	90-201-29.....	56
30-473-30.....	49	30-724-16.....	51	80-090-04.....	41	80-622-56.....	11	90-202-01.....	56
30-475-01.....	47	30-724-19.....	51	80-090-05.....	41	80-623-22.....	11	90-202-02.....	56
30-475-02.....	47	30-726-13.....	51	80-090-07.....	40	80-631-10.....	66	90-204-01.....	57
30-477-10.....	49	30-726-16.....	51	80-090-08.....	41	80-631-12.....	66	90-204-02.....	57
30-477-20.....	49	30-728-16.....	51	80-090-09.....	41	80-631-14.....	66	90-206-01.....	57
30-477-30.....	49	30-729-16.....	51	80-090-10.....	41	80-631-21.....	66	90-206-02.....	57
30-477-40.....	49	30-732-13.....	51	80-090-11.....	41	80-632-00.....	66	90-206-03.....	57
30-477-50.....	49	30-732-16.....	51	80-090-12.....	41	80-632-01.....	66	90-206-04.....	57
30-477-60.....	49	30-732-19.....	51	80-090-13.....	41	80-632-02.....	66	90-208-01.....	57
30-478-10.....	49	30-733-16.....	51	80-090-14.....	41	80-632-03.....	66	90-208-02.....	57
30-478-20.....	49	30-734-16.....	51	80-090-15.....	41	80-632-04.....	66	90-210-01.....	57
30-478-30.....	49	30-735-19.....	51	80-090-16.....	41	80-632-05.....	66	90-210-02.....	57
30-478-40.....	49	30-740-10.....	52	80-090-17.....	41	80-641-14.....	66	90-210-03.....	58
30-478-50.....	49	30-740-30.....	52	80-110-16.....	23	80-642-00.....	66	90-210-04.....	58
30-478-60.....	49	30-740-31.....	52	80-125-03.....	54	80-642-01.....	66	90-210-05.....	58
30-479-10.....	49	30-740-40.....	52	80-125-07.....	54	80-642-02.....	66	90-210-06.....	58
30-479-20.....	49	30-742-19.....	52	80-125-12.....	54	80-642-03.....	66	90-210-07.....	58
30-479-30.....	49	30-743-19.....	52	80-302-12.....	62	80-642-04.....	66	90-210-08.....	58
30-479-40.....	49	30-744-19.....	52	80-302-14.....	62	80-642-05.....	66	90-210-09.....	58
30-479-50.....	49	30-747-06.....	53	80-302-16.....	62	80-661-12.....	66	90-210-10.....	58
30-479-60.....	49	30-747-07.....	53	80-306-17.....	62	80-661-14.....	66	90-211-01.....	58
30-483-10.....	49	30-747-08.....	53	80-306-22.....	62	80-661-21.....	66	90-212-01.....	59
30-483-20.....	49	30-747-09.....	53	80-306-30.....	62	80-662-00.....	66	90-212-02.....	59
30-483-30.....	49	30-747-10.....	53	80-308-07.....	63	80-662-01.....	66	90-212-03.....	59
30-483-40.....	49	30-747-12.....	53	80-308-10.....	63	80-662-02.....	66	90-213-00.....	59
30-483-50.....	49	30-747-15.....	53	80-308-15.....	63	80-662-03.....	66	90-214-00.....	59
30-483-60.....	49	30-749-15.....	53	80-308-20.....	63	80-662-04.....	66	90-215-00.....	59
30-484-10.....	49	30-759-21.....	53	80-320-30.....	42	80-662-05.....	66	90-220-00.....	60
30-484-20.....	49	30-770-30.....	53	80-321-30.....	42	80-671-20.....	66	90-222-04.....	60
30-484-30.....	49	30-770-50.....	53	80-322-30.....	42	80-671-25.....	66	90-222-05.....	60
30-484-40.....	49	30-805-00.....	61	80-324-40.....	42	80-671-40.....	66	90-222-06.....	60
30-484-50.....	49	30-807-01.....	61	80-334-16.....	63	80-671-60.....	66	90-222-08.....	60
30-484-60.....	49	30-807-02.....	61	80-416-45.....	23	80-681-01.....	66	90-222-10.....	60
30-485-10.....	49	30-807-03.....	61	80-417-45.....	23	80-681-02.....	66	90-222-12.....	60
30-485-20.....	49	30-809-01.....	61	80-419-45.....	23	80-681-03.....	66		
30-485-30.....	49	30-809-02.....	61	80-501-01.....	64	80-681-04.....	66		
30-485-40.....	49	30-812-24.....	61	80-501-02.....	64	80-681-05.....	66		
30-485-50.....	49	30-814-19.....	61	80-501-03.....	64	80-681-06.....	66		
30-485-60.....	49	30-816-40.....	61	80-501-04.....	64	80-681-07.....	66		
30-485-10TAN.....	49	30-817-40.....	62	80-503-03.....	64	80-683-10.....	67		
30-485-40TAN.....	49	30-900-00.....	68	80-504-05.....	64	80-684-10.....	67		
30-490-40.....	48	30-902-00.....	70	80-506-30.....	64	80-688-00.....	67		
30-491-40.....	48	30-905-00.....	69	80-507-40.....	64	80-690-01.....	67		
30-492-40.....	48	70-203-00.....	17	80-509-75.....	64	80-690-02.....	67		
30-493-40.....	48	70-211-00.....	14	80-512-00.....	64	80-691-01.....	67		
30-494-40.....	48	70-211-01.....	14	80-515-06.....	64	80-692-01.....	67		
30-700-00.....	50	70-211-10.....	14	80-515-08.....	64	90-201-01.....	54		
30-700-01.....	50	70-211-20.....	14	80-515-10.....	64	90-201-02.....	55		
30-702-25.....	50	70-211-30.....	14	80-517-00.....	64	90-201-03.....	55		
30-703-25.....	50	70-211-40.....	14	80-519-00.....	65	90-201-04.....	55		
30-705-55.....	50	70-211-50.....	14	80-519-01.....	65	90-201-05.....	55		
30-705-65.....	50	70-258-35.....	17	80-519-02.....	65	90-201-06.....	55		
30-705-75.....	50	70-259-35.....	17	80-519-03.....	65	90-201-07.....	55		
30-706-55.....	50	70-260-35.....	17	80-520-06.....	65	90-201-08.....	55		
30-706-65.....	50	70-265-01.....	17	80-520-08.....	65	90-201-09.....	55		
30-706-75.....	50	70-265-02.....	17	80-525-17.....	65	90-201-14.....	56		

Umrechnungstabelle - Ch/Fr - mm - inch

Conversion table - Ch/Fr - mm - inch

Charrière (CH) French (F)	mm	Inch
1	0,33	0,013
2	0,67	0,025
3	1,00	0,039
4	1,33	0,051
5	1,67	0,065
6	2,00	0,079
7	2,33	0,092
8	2,67	0,105
9	3,00	0,118
10	3,33	0,131
11	3,67	0,144
12	4,00	0,156
13	4,33	0,170
14	4,67	0,184
15	5,00	0,197
16	5,33	0,210
17	5,67	0,223
18	6,00	0,237
19	6,33	0,249
20	6,67	0,263
21	7,00	0,276
22	7,33	0,288
23	7,67	0,302
24	8,00	0,315
25	8,33	0,328
26	8,67	0,341
27	9,00	0,354
28	9,33	0,367
29	9,67	0,380
31	10,23	0,407
32	10,67	0,420
34	11,33	0,446
36	12,00	0,472
38	12,67	0,494
40	13,33	0,520
45	15,00	0,591



© 2020 by SPIGGLE & THEIS Medizintechnik GmbH

Änderungen und Irrtümer – einschließlich Bilder - vorbehalten.
Produktsortiment kann pro Land abweichen.

Modifications and errors – including pictures – reserved.
Product range might vary per country.



Burghof 14 · 51491 Overath · Germany
Phone: +49 2206 90 81 - 0
Fax: +49 2206 90 81 - 13
info@spiggle-theis.com
www.spiggle-theis.com